



ESSILOR INTERNATIONAL - R.C.S. Créteil B712 049 618 - P1004E - update 12/13

M'Eye E.STORE

THE ESSILOR EXPERTISE FOR YOUR DAILY NEEDS



M'Eye E.STORE

THE ESSILOR EXPERTISE FOR YOUR DAILY NEEDS



To allow ongoing improvements, these specifications are non-contractual and are subject to modification without notice.

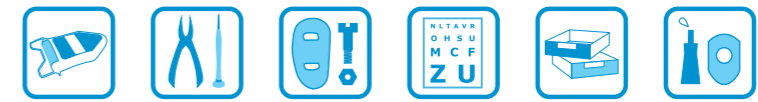

Essilor Instruments has chosen to renew its range of tools, small equipments and consumables for your workshop, your refraction room and dispensing.

M'Eye e-store is a large selection enriched with many references that meet your daily expectations.

It complements a wide range of instruments for your practice.



CONTENTS

EQUIPMENT

FITTING MEASUREMENTS

AUTOMATIC LENSMETERS

OCULAR LENSMETERS- LENS ENGRAVINGS DETECTOR

LENS STRESS DETETORS PHOTOCHROMIC AND UV TESTERS

ULTRASONIC CLEANERS

FRAME HEATERS

POLISHING MACHINE AND GROOVER

HAND EDGERS

DRILLING DEVICES

TINTING MACHINES

FILTERING SYSTEMS

TOOLS

PLIERS

TWEEZERS

HAND FILES

REAMERS - NEEDLE FILES SAWS

DRILLS AND MILLERS

SCREWDRIVERS AND NUTDRIVERS

SETS ROTATING - THIRD HAND -SOLDERING TOOLS

SMALL TOOLS - STAKING TOOLS

MEASURING TOOLS

SUITECASES

FRAME PARTS

NOSE PADS

NOSE BRIDGES - PAD ARMS - NYLON THREADS

SCREWS

SCREWS - RIMLESS PARTS

RIMLESS NUTS - WASHERS - RIMLOCK - RIMLESS DOME NUTS

HINGES

HINGES - TEMPLES

TEMPLES

TEMPLES - TEMPLES ENDS

TEMPLE ENDS - SPECTACLE CORDS - ASSORTMENTS

THE ESSENTIALS

OPTOMETRY

TRIAL CASES AND TRIAL FRAME

PROXIMETER

OPTOMETRIC ACCESSORIES

OCCCLUSION FOILS

PRISMS AND ASPHERICAL LENSES

WORKING AIDS

JOB TRAYS

STORAGE BOXES

LIQUID CONTAINERS

TOOL STANDS

CONSUMABLES

CLEANING

GLUE - TINTS

MARKING - NYLOR FRAMES

POLISHING - SOLDERING ROUGHINGS

PADS AND BLOCKS

EDGING, CHAMFERING, GROOVING WHEELS

BULBS

CONSUMABLES AND ACCESSORIES FOR INSTRUMENTS

EDGERS - TRACERS

OTHER WORKSHOP EQUIPMENT

FITTING TOOLS - LENS DEMONSTRATORS

LENSMETERS

REFRACTION INSTRUMENTS



EQUIPMENT

| | |
|---------------------------------------------------------|------|
| FITTING MEASUREMENTS | 1-2 |
| AUTOMATIC LENSMETERS | 1-4 |
| OCULAR LENSMETERS - LENS ENGRAVINGS DETECTOR | 1-8 |
| LENS STRESS DETECTORS - PHOTOCHROMIC AND UV DETECTOR | 1-10 |
| ULTRASONIC CLEANER | 1-12 |
| FRAME HEATERS | 1-14 |
| POLISHING MACHINES AND GROOVERS | 1-16 |
| HAND EDGERS | 1-18 |
| DRILLING DEVICES | 1-20 |
| TINTING MACHINES | 1-22 |
| FILTERING SYSTEMS | 1-24 |





DIGITAL CRP PUPILLOMETER

REF : X81705

The corneal reflection pupillometer for precise and digital PD measurements.

- Measuring of the monocular and binocular PD for all distances between 35 cm and infinity.
- Monocular PDs can be measured by occluding one eye if the patient's binocular vision is abnormal.
- Digital display of monocular and binocular PDs from 48 to 77 mm (step: 0.5mm).
- Automatic standby.
- Dimensions: L250 x P160 x H60 mm.
- Weight: 0.7 kg.
- Powered by two 1.5 V batteries.
- CE conformity marking.



ACCESSOIRES

Retrofit kit

MHPS50

DITEST

REF : N73700

The Ditest allows the minimum lens diameter to be determined during initial dispensing, and final checking after glazing.

- Delivered with cards covering most Essilor lens types.
- Dimensions: L250 x W150 x H35 mm.
- Weight: 0.5 kg.



MIROIR VP

REF : N71700

Placed between the customer and the ECP, the VP system enables the near vision PD measurements.

- Powered by two 1.5 V batteries.
- Dimensions: L125 x W175 x H65 mm.
- Weight: 0.5 kg.
- CE conformity marking.

3 ESSENTIAL TOOLS FOR PAL FITTINGS

1 MHP
1 DITEST
1 PUPILLOMETER

= VARILUX DISPENSING KIT



Varilux Dispensing Kit
Ref : VDK001





+ FAST AND PRACTICAL
ADAPTED TO ALL EQUIPMENTS
GREEN LIGHT IN THE HEART OF
PRECISION



ALM 500 AUTOMATIC LENSMETER

REF : ALM500

Compact, practice, fast and elegant
The ALM 500 measures all types of lenses and frames precisely.

- Its tiltable colour screen provides ergonomic comfort for operators.
- Adjustable frame holder with graduated scale allows quick and easy measurement of the right eye / left eye height differential.
- Intuitive software ensures clear data displays and fast navigation
- The use of green light similar to standard ISO07944 eliminates the need to enter Abbe number.
- Measures all types of lenses and contact lenses, class 4 tinted lenses including.
- The lens support adapts to all lenses and frame cambers.
- Measurement range:
 - Sphere : -25.00D ~ +25.00D (0.01 / 0.12 / 0.25).
 - Cylinder: 0.00D ~ ±10.00 (0.01 / 0.12 / 0.25).
 - Axis : 1 to 180° (1°).
 - Addition : 0 à +10D (0.01 / 0.12 / 0.25).
 - Prisme : 0 à 10 Δ (0.01 / 0.12 / 0.25).

- Maximum lens diameter: 100 mm.
- Thermal printer.
- RS232C output
- Dimensions : L 170 x P 205 x H 468 mm.
- Weight : 4.3 kg.
- Power Supply : 110/240 V – 50/60 Hz.
- CE marking compliance.
- Complies with the ISO 8598 standard.

ACCESSORIES

| | |
|---------------------|--------|
| Lens clamp | ALM002 |
| Lens holder | ALM026 |
| Paper roll | CD8020 |
| Contact lens holder | ALM504 |



+ MEASURES INTER-PUPILLARY DISTANCE
 MEASURES UV TRANSMISSION
 TILTABLE TOUCH SCREEN



ALM 700 AUTOMATIC LENSMETER

REF : ALM700

Compact, elegant and practical, the ALM 700 speeds the accurate measurement of your frames and lenses, UV transmission and PD measurements included.

- Tiltable colour screen equipped with a highly reactive touch screen.
- Measurement accuracy secured regardless of the lens index and abbe number.
- Exclusive design featuring two nose supports enabling a simple and rapid PD measurements.
- Adjustable frame rest with graduated scale.
- Simultaneous measurement of the lens power and UV transmission.
- Adapted to all types of lenses and frames, including class 4 tinted and high curved
- Measurement range:
 - Sphere: -25.00D ~ +25.00D (0.01 / 0.12 / 0.25).
 - Cylinder: 0.00D ~ ±10.00 (0.01 / 0.12 / 0.25).
 - Axis: 1 to 180° (1°).
 - Addition: 0 à +10D (0.01 / 0.12 / 0.25).
 - Prism: 0 à 10 Δ (0.01 / 0.12 / 0.25).
 - UV Transmission : 0 to 100% (-25D, +25D).
- Maximum diameter: 100 mm.
- UV transmission: 0 to 100% at 375 nm (1%).
- PD between 45 and 85 mm (0.5 mm).
- Thermal printer.
- RS 232C output and USB port.
- Dimensions: (W) 170 x (D) 205 x (H) 468 mm.
- Weight: 4.3 kg.
- Voltage: 100/240v – 50/60 Hz
- CE conformity marking.
- Complies with the ISO 8598 standard relative to focimeters.

ACCESSORIES

| | |
|-----------------------------------|--------|
| Set of 3 marking pins (white ink) | ALM501 |
| Lens clamp | ALM502 |
| Lens holder | ALM503 |
| Paper roll | CD8020 |
| Contact lens holder | ALM504 |



LED ILLUMINATION TARGET
HIGH & WIDE FIELD EYEPIECE



MLM100



MLM100C

MLM 100 OCULAR LENSMETER

REF : MLM100 & MLM100C

THE MLM 100 is a classic lensmeter model which is battery operated with LED-light.

- LED illuminated target for brighter, glare-free viewing.
- Available in two versions: "Crosshair" or "Ring" type targets.
- High and wide field eyepiece provides less shading effect and is less fatiguing.
- Improved marking device.
- Contact lens measurement.
- Measurement range:
 - Sphere: +/- 25 δ
 - Cylinder: +/- 6 δ
 - Axis: 1 to 180°
 - Addition: 0 to 10 δ
 - Prism: 0 to 10 Δ.
- Increment: 0.125 and 0.25 δ.
- Dimensions: L420 X W160 X H310 mm.
- Weight: 4.0 kg.
- Battery operated.
- CE conformity marking.
- **Option:** prism compensator.

PAL-ID LENS ENGRAVING DETECTOR

REF : PAL000

PAL ID makes it much easier to read lens engravings.

- Easy lens engraving identification whatever the type: organic, polycarbonate, mineral.
- In the workshop, it is easier to find FV and NV tests points.
- In the dispensing, the customer can check, by himself, the manufacturer's mark.
- Delivered with 2 filters:
 - one for organic and polycarbonate lenses;
 - the other one for mineral lenses.
- Dimensions: L145 X W260 X H320 mm.
- Weight: 2.0 kg.
- Voltage: 220 V - 50 Hz.
- CE conformity marking.



INSTANT LENS ENGRAVINGS
IDENTIFICATION **W**HATEVER
THE MATERIAL

ACCESSORIES

| | |
|-------------------------------|--------|
| Set of 3 red ink cartridges | MLMRI3 |
| Set of 3 white ink cartridges | MLMWI3 |
| Set of 10 lens holders | MLMP10 |
| Ocular protection | MLM105 |
| Prism Compensator (option) | MLM1PC |
| 100 - 220 V power supply | MLM1SA |

ACCESSORIES

| | |
|-------------------------------------------|--------|
| Fluorescent tube | CA5050 |
| Filter for mineral lens | PALA02 |
| Filter for organic and polycarbonate lens | PALA01 |

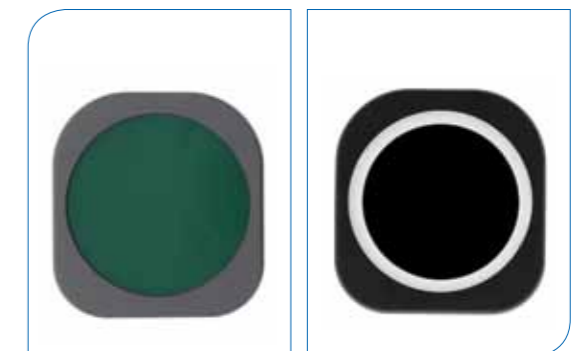



TEN 070 TENSISCOPE

REF : TEN070

The tensiscope makes it possible to identify tensions or stress on mounted lenses.

- If wrongly applied, such stress can cause distortion and, in glass lenses, chips.
- Tension is always applied when, mounting a lens, any excessive tensioning shown by the tensiometer must be eliminated.
- Dimensions: L155 X W135 X H167 mm.
- Weight: 1.0 kg.
- Voltage: 120V - 60 Hz ou 230 V-50 Hz.
- CE conformity marking.

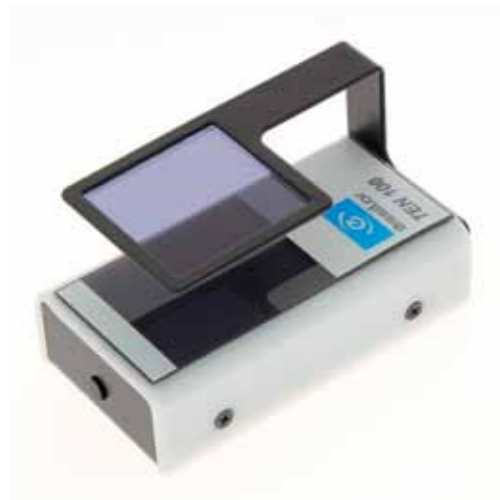

TEN 100 HAND TENSISCOPE

REF : TEN100

Ultra compact and portable Tensiscope for checking stress on mounted lenses.

- Dimensions : L100 X W48 X H55 mm.
- Weight: 175 g.
- 9V battery supplied.
- CE conformity marking.



DPE 100 PHOTOCHROMIC & UV TESTER

REF : DPE100

DPE 100 is a demonstration tool combining UV tester and photochromic detector.

- The photochromic lenses reach their darkest absorption in 15 sec.
- Reference scale to compare lenses.
- Instant UV test.
- Dimensions: L220 x W120 x H125 mm.
- Weight: 1.7 kg.
- Voltage: 220 V/50 Hz or 115 V/60 Hz.
- CE conformity marking.

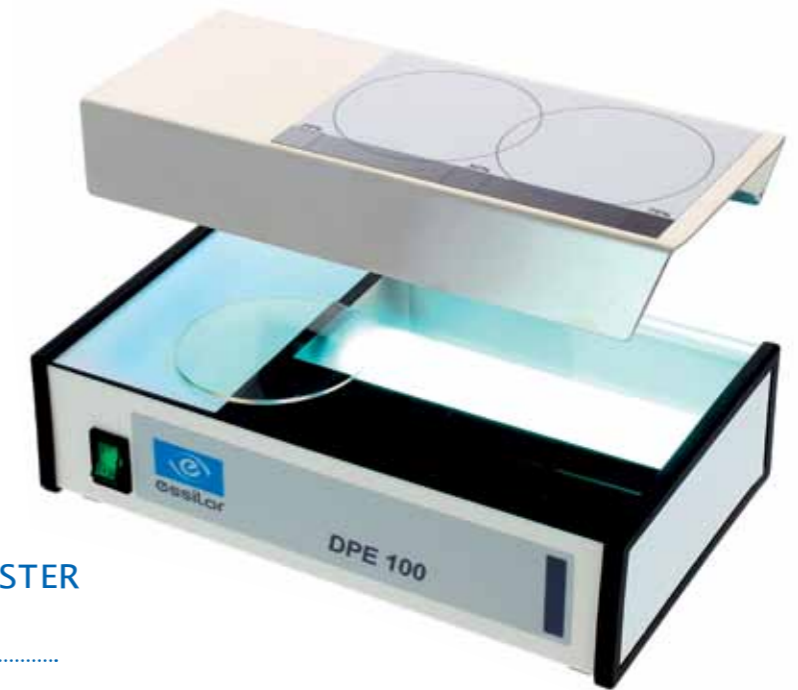

TWO IN ONE :
PHOTOCHROMIC TESTER + UV TESTER

ACCESSORIES

UV Lamp

DPE111





MNU 300 ULTRASONIC CLEANER

REF: MNU300

For intensive cleaning.

- 2 liter tank for capacity cleaning of up to 3 frames simultaneously.
- High-frequency waves for in-depth cleaning of delicate optics.
- Adjustable timer and digital display.
- Stainless steel tank.
- Plastic tray to reduce risk of scratching on lenses
- Effective ultrasonic power 160 W.
- Dimensions : L 265 x P 230 x H 180 mm.
- Weight : 2.2 kg.
- Power supply: 220/240 V-50 Hz.
- CE conformity marking.



CAPACITY UP TO 3 FRAMES

MULTIPLE FUNCTIONS: HEATING, TIMER,
DIGITAL DISPLAY.



MNU 180 ULTRASONIC CLEANER

REF: MNU180

Ideal for intensive use.

- Cleaning tank made of special stainless steel.
- Capacity: 0.8 liter.
- Selector dial for easy selection of cleaning time.
- Time setting adjustment: permanent operation or adjustable between 1 and 30 min.
- Delivered with cover and rack.
- Effective ultrasonic power: 30 W.
- Dimensions: L206 X W116 X H178 mm.
- Weight: 2.0 kg.
- Voltage: 100/240 V – 50/60 Hz.
- CE conformity marking.



MNU 100 ULTRASONIC CLEANER

REF: MNU100

Compact and quiet for dispensing area.

- 0.6 liter stainless steel tank.
- Built-in timer with pre-sets of 3, 5 or 10 min.
- Supplied with integrated cover and plastic tray.
- Effective ultrasonic power 50 W.
- Dimensions : L 210 x P 150 x H 140 mm.
- Weight: 0.92 kg.
- Power supply : 220/240 V-50 Hz..
- CE conformity marking.



Cleaning solution
available in the
Consumables section



FHE 300 FRAME HEATER

REF : FHE300

Frame heater with electronic heating regulation for easy frame adjustments.

- Two levels of temperature : 65/90°C and 130/170°C.
- Cooling function.
- Large platform allowing perfect frame heat position.
- Homogeneous temperature in the working area.
- Delivered with hot air concentrator.
- Dimensions: L15 x W190 x H215 mm.
- Weight: 2.6 kg.
- Voltage: 220/230 V-50 Hz and 115 V- 60 Hz.
- CE conformity marking.



FHE 100 FRAME HEATER

REF : FHE100

Frame heater with electronic heating regulation. Can be inserted into a bench.

- Two levels of temperature: 60/100°C and 110/150°C .
- Homogeneous temperature in the working area.
- Delivered with hot air concentrator.
- Dimensions: L144 x W200 x H213 mm.
- Weight: 2.0 kg.
- Voltage :220/230 V-50 Hz and 115 V-60 Hz.
- CE conformity marking.



FHE 200 FRAME HEATER

REF : FHE200

The compact design of this frame heater suits any working space.

- Temperature : ~120°C.
- Dimensions: L140 x W140 x H290 mm.
- Weight: 2.6 kg.
- Voltage :220/230 V - 50 Hz and 115 V - 60 Hz.
- CE conformity marking.



LARGE PLATFORM

ELECTRONIC HEATING REGULATION
COOLING FUNCTION





TPO 800
POLISHING AND SANDING
MACHINE
REF: TPO800

Polishing and sanding machine.

- 2 speeds: 1500 and 3000 rpm.
- Delivered with right side wheel adapter and two conical tips.
- Dimensions: L470 x W220 x H240 mm.
- Weight: 2 kg.
- Voltage: 220 V – 50 Hz.
- CE conformity marking.

■ **Options:**

- Metal protection cover.
- Silicon protection cover.



2 SPEEDS FOR
ALL USAGES



MRT 700
AUTOMATIC GROOVER
REF: MRT700

Automatic groover for rapid Nylon mountings.

- Adjustable grooving position.
- Grooving time: ≈ 40 seconds.
- Organic and mineral lenses.
- Dimensions: L170 x W210 x H150 mm.
- Weight: 3.5 kg.
- Voltage: 220 V/50 Hz or 115 V/60 Hz.
- CE conformity marking.

■ **Option:**

- Small B size adapter.

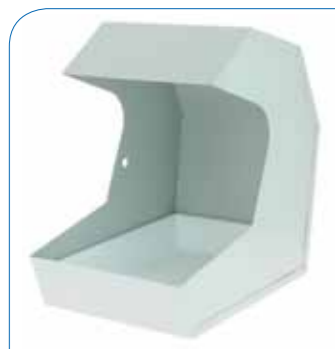

ACCESSORIES

| | |
|--------------------------|--------|
| Metal protection cover | TPO810 |
| Silicon protection cover | TPO811 |
| Left tool support | TPO821 |
| Right cone | TPO825 |
| Left cone | TPO826 |

ACCESSORIES

| | |
|-----------------------------|--------|
| Small B size adapter | MRT930 |
| Edger adapter – Gamma/Kappa | MRTA10 |
| Sponge | MRT904 |
| Centring pin | MRT963 |
| Rubber lens chuck | MRT926 |





**MMW
HAND EDGER**

REF : MMW001

Hand edger with cylindrical wheels, ideal for roughing, finishing, chamfering and retouching work.

- Standard version: one finishing wheel.
- Large diamond wheels, 25 mm, Ø 150 mm.
- Dimensions: L230 x W380 x H275 mm.
- Weight: 16.0 kg.
- Voltage: 220 V/50 Hz or 115 V/60 Hz.
- CE conformity marking.

Options:

- Roughing wheel,
- Polishing wheel,
- Water mains connection kit.



WORKS IN CLOSED CIRCUIT
OR CITY WATER CONNECTION



**DIAFINE
HAND EDGER**

REF : N65803 & N65807

A range of manual edgers for chamfering and polishing.

- Conical diamond wheels from 50 to 90 mm in diameter.

- Two 14 mm wide strips for chamfering and counter-beveling at the best possible angle.

- Retouching mini bevels with either the left hand or the right hand side of the wheel.

- Extra possibility: mini-beveling on thin lens (as sunglass lens).

- Continuously lubricated by a film of water which eliminates any risk of splashing.

- Built-in container.

- Dimensions: W160 x D250 x H170 mm.

- Weight: 4.6 kg.

- Voltage: 220 V-50 Hz / 115 V-60 Hz.

- CE conformity marking.

Diafine Poly : chamfering and polishing for polycarbonate and organic bevelled lenses.



Standard Diafine : chamfering for mineral and organic lenses.

ACCESSORIES

| | |
|---------------------------------------------|--------|
| Cleaning stone for roughing wheel (10 pcs) | MMW10S |
| Cleaning stone for finishing wheel (10 pcs) | MMW10R |
| Large sponge | MMW10A |
| Small sponge | MMW10B |
| Plexiglas hood | MMW10H |

ACCESSORIES

| | |
|-------------------------|--------|
| Sponge (3Pcs) | GAM094 |
| Bumper | CY6008 |
| Mineral / Organic wheel | CX3031 |
| Polycarbonate Wheel | CX3030 |
| Tank | N6510D |



Edging wheels available in the **Consumables** section

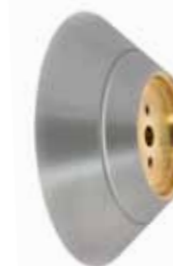

Edging wheels available in the **Consumables** section





PER 200
DRILLING COLUMN
REF : PER200

Manual drilling column allowing precise holes.

- It realizes holes and slot-shaped holes.
- Horizontally pivoted cylinder for oblique holes.
- Possibility of column lock during descent.
- Angle of drill head for pantoscopic angle.
- Dimensions: L215 x W180 x H360 mm.
- Weight: 4.7 kg.



PER 201
REF : PER201

Manual drilling/milling.

- Easy to handle.
- Motor speed adjustable from 5 000 to 20 000 rpm.
- Delivered with six high quality steel collets: 1.0 – 1.5 – 2.0 – 3.0 – 3.2 mm.
- Dimensions: L 220 x Ø 35 mm.
- Weight: 230 g.
- CE conformity marking.

PER 100
BENCH DRILL MACHINE
REF : PER100

This bench drill machine enables precision work in drilling screws, hinges and temples.

- Motor: 220-240 V 85 W.
- Power transmission by flat belt.
- 3 spindle speeds: 1800, 4700 and 8500 rpm.
- Feed level with adjustable depth scale.
- Universal chuck with 6 jaws.
- Hard-chrome steel column: 180x 20mm.
- Tabletop size: 220 x 120 mm.
- Dimensions: L120xW220xH280 mm.
- Weight: 3.3 kg.
- Voltage: 220 V/240 V - 50 Hz.
- CE conformity marking.



Drill bits and mills
available in the
Tool section



ACCESSORIES PER 200

| | |
|----------------------------|--------|
| ESSILOR Adapter | PER210 |
| ESSILOR Profil M Adapter | PER211 |
| NIDEK, WECO, BRIOT Adapter | PER220 |
| NIDEK, INDO-HOYA Adaptater | PER221 |
| Lens clamp Rubber | PER230 |

ACCESSORIES

| | |
|------------------|--------|
| Drilling support | PER001 |
| Drilling clamp | PER002 |





TIN 700 LENS COLORING

REF : TIN700

Organic lens colouring oil bath.

- Homogeneous temperature in the oil bath.
- Thermostat for temperature regulation and keeping.
- Timer for pre-heating regulation.
- Harmless silicone oil, free from odours and fumes.
- 7 pots with handle to make cleaning and emptying easy.
- Dim.: L442 x W442 x H330 mm.
- Weight: 14.0 kg.
- Voltage: 220/240 V-50 Hz and 115 V - 60 Hz.
- CE conformity marking.

■ **Option** : Lens clamps, pots.



TIN 400 AND TIN 200 LENS COLORING

REF : TIN400 & TIN200

2 models of organic lens colouring machines with electric plates.

- Two levels of temperature: 80-85°C and 85-93°C.
- Energy regulator - one per each couple of plates.
- Automatic temperature keeping at 93°C approx. during process.
- TIN 200:
 - 2 electric plates-2 pots included.
 - Dim.: L 160 x W 430 x H 220 mm.
 - Weight: 4.2 kg.
- TIN 400:
 - 4 electric plates- 4 pots included.
 - Dim.: L 315 x W 430 x H 220 mm.
 - Weight: 8.9 kg.
- Voltage: 220 V/240 V - 50 Hz.
- CE conformity marking.



COMMON ACCESSORIES

| | |
|--------------------------|--------|
| Pot with right handle | TIN020 |
| Pot with curved handle | TIN021 |
| Metal lens holder (x2) | TIN010 |
| Metal lens holder (x4) | TIN011 |
| Plastic lens holder (x2) | TIN012 |



Tinting accessories
available in
Consumables section



AN UNIVERSAL FILTERING SYSTEM IN A CLOSED CIRCUIT, EFFECTIVE TO MINIMIZE YOUR WATER USE AND OPTIMIZE YOUR BUDGET



NEPTUNE MINI REF : NEPT01

- Use up to 15 frames per day.
- Filter change: after every 1.200 lenses.
- Odor absorber (optional): two active principles of zinc ricinoleate and activated carbon.
- Tank: thermoformed ABS. C apacity: 25 liters.
- Water circuit: PVC, can be fully dismantled and is easy to clean.
- Dimensions and weight: 350 (W) X 500 (D) X 690 (H) mm.
- Dimensions of Neptune with odor absorber: 350 (W) X 500 (D) X 690 (H) mm
- Electric power: 130W.
- Power supply: 110/230 V - 50/60 V.
- CE marking compliant.



NEPTUNE REF : NEPT02

- Use up to 50 frames per days.
- Filter change: after every 1.500 lenses.
- Odor absorber (optional): two active principles of zinc ricinoleate and activated carbon.
- Tank: thermoformed ABS. C apacity: 50 liters.
- Water circuit: PVC, can be fully dismantled and is easy to clean.
- Dimensions and weight: 550 (W) X 500 (D) X 685 (H) mm.
- Dimensions of Neptune with odor absorber: 550 (W) X 500 (D) X 715 (H) mm.
- Electric power: 350W.
- Power supply: 110/230 V - 50/60 V.
- CE marking compliant.

ACCESSORIES

| Filtration Bag | |
|-------------------|--------|
| ■ Neptune Mini | NEPT11 |
| ■ Neptune Classic | NEPT12 |

OPTIONS

| Water supply pump of the edger | |
|--------------------------------|--------|
| ■ Out water pump | N37501 |
| ■ In water pump | M05S50 |

COMPATIBLE WITH ALL THE EDGERS RANGE



MINIMIZE WATER CONSUMPTION :

- Neptune has an exclusive closed circuit filtration system that provides a water consumption reduction of nearly 150 liters per day (equivalent to a tanker truck per year).
- Weekly level control prescription.
- Daily filtered, the water can be reused up to 6 months.

Without Neptune



With Neptune



EFFICIENT :

- Neptune works in a closed circuit, in excellent conditions with a double filtration system.
- The day, the filtration is done by sieve and decantation, insuring the arrival of clear water to the edger.
- The evening, water will be filtered and the container cleaned several times, delivering clean water for the work environment.



EASY TO USE :

- The Plug & Play installation needs no plombery, and adapts to every edger machine.
- Equipped with a minimalist and complet control box, Neptune is easy to use, besides it has an easy maintenance thanks to an elementary and robust design.
- The filter change is only needed after 1.500 lenses (1.200 for Neptune Mini).

BENEFICIAL FOR YOUR ENVIRONMENT :

- **The edger:** thanks to Neptune, the scale deposits and the limestone are strongly limited.
- **The workshop:** without plombery, the edger can be put in the heart of the workshop emphasizing the technicity of your profession. The water pipelines are preserved (none degradation because of charged water). An odor-absorber is optional and at your disposal to reduce the MHI odours.
- **L'environnement:** with the filtering system water consumptions is almost zero and the respect of wasted water rules is ensured.



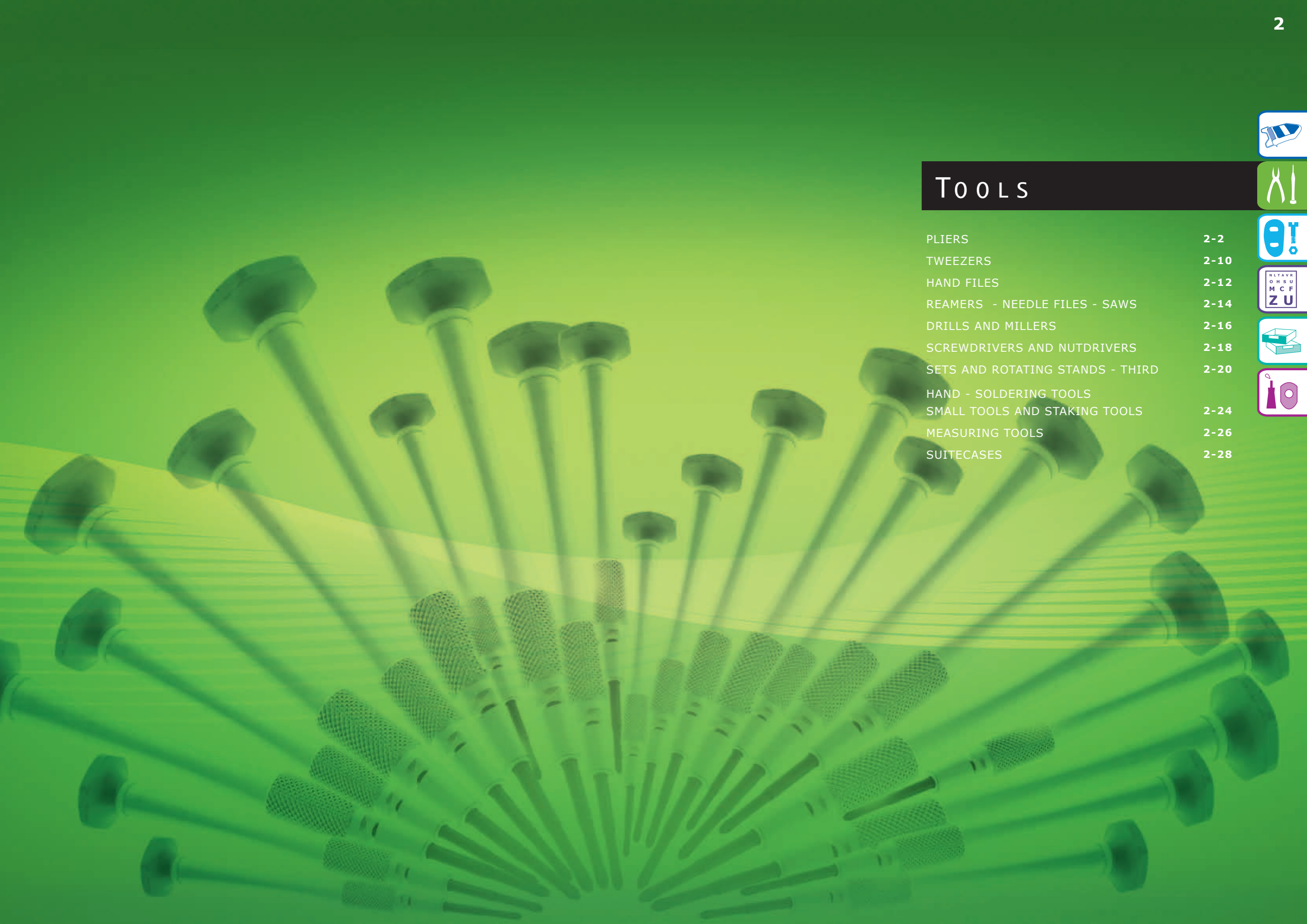

TOOLS

| | |
|----------------------------------|------|
| PLIERS | 2-2 |
| TWEEZERS | 2-10 |
| HAND FILES | 2-12 |
| REAMERS - NEEDLE FILES - SAWS | 2-14 |
| DRILLS AND MILLERS | 2-16 |
| SCREWDRIVERS AND NUTDRIVERS | 2-18 |
| SETS AND ROTATING STANDS - THIRD | 2-20 |
| HAND - SOLDERING TOOLS | |
| SMALL TOOLS AND STAKING TOOLS | 2-24 |
| MEASURING TOOLS | 2-26 |
| SUITECASES | 2-28 |



ADJUSTMENT PLIERS



Forming plier
Ref: PIN002
 Stainless steel - 2 nylon jaws Ø24 mm
 △ 100 gr - ► 140 mm
Replacement jaws Ref: PINPD2



Eyewire shaper
Ref: PIN022
 With blocking notch - Stainless steel
 △ 100 gr - ► 155 mm
Replacement jaws Ref: PINP22



Inclination plier
Ref: PIN003
 To adjust temples and joints - V mandal jaw and 11 mm nylon jaw - Stainless steel
 △ 100 gr - ► 140 mm
Replacement jaws - Ref: PINPD3



Inclination conical plier
Ref: PIN004
 To adjust pad arms, temples and joints
 Conical mandal jaw and nylon jaw of 7 mm.
 Stainless steel - △ 100 gr - ► 140 mm
Replacement jaws Ref: PINPD4



Nose plier
Ref: PIN008
 Stainless steel - Jaws : 4 mm
 △ 100gr - ► 140 mm



Angling plier or hinge setting
Ref: PIN007
 Stainless steel
 △ 100 gr - ► 130 mm



Holding plier
Ref: PIN017
 Stainless steel - 2 nylon jaws of 7 mm
 △ 100 gr - ► 140 mm
Replacement jaws Ref: PINP17



Circle modifying plier
Ref: PIN019
 Stainless steel
 △ 120 gr - ► 150 mm
Replacement jaws Ref: PINP19



Nylon thread hook
Ref: OFN001
 Stainless steel
 △ 20 gr - ► 105 mm
Set of 3 replacement hook- Ref: OFN010



Assembly plier
Ref: PIN023
 Sand and screw on assembly screws - screw is inserted in the hollow of one of the jaws -
 Stainless steel - △ 160 gr - ► 155 mm



ALL PURPOSE PLIERS



Size testing plier
Ref: PIN015

To check lens size - Stainless steel
△ 100 gr - ▷ 140 mm



Half round long nose snipe plier

Ref: PIN016
Stainless steel
△ 100 gr - ▷ 140 mm



Curved screw holding plier

Ref: PIN020
Stainless steel
△ 120 gr - ▷ 140 mm



Clamping plier

Ref: PIN026
Stainless steel
△ 33 gr - ▷ 150 mm

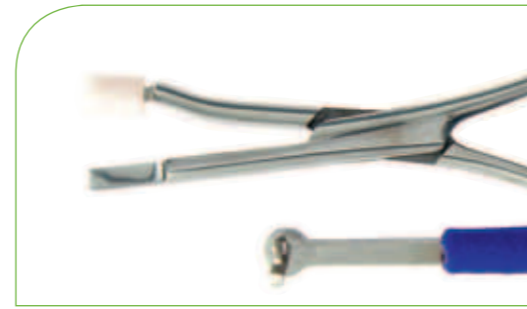

Plier for flex temples

Ref: PIN032
Stainless steel
△ 63 gr - ▷ 140 mm
Replacement jaws Ref: PIN033



Round nose plier with fine tapered jaws

Ref: PIN013
Stainless steel
△ 100 gr - ▷ 150 mm



Flaring plier

Ref: PIN006
With adjustable pin - Stainless steel
△ 120 gr - ▷ 150 mm
Replacement pin Ref: PINPD6



Flat nose plier

Ref: PIN009
Stainless steel - wide jaws: 4 mm
△ 120 gr - ▷ 150 mm



Plier grips

Ref: PING01
5 pairs of plier grips in 5 colors
△ 46 gr - ▷ 110 mm

SPECIAL PLIERS



Lens axis plier
Ref: PIN005
 Stainless steel - Ø 26 mm and 32 mm
 △ 100 gr - ▷ 140 mm
Replacement jaws - Ref: PINPD5



Sucker removing plier
Ref: PIN014
 Stainless steel - grooved jaws
 △ 110 gr - ▷ 150 mm



Half frame lens axis plier
Ref: PIN021
 Oval 20 x 12 mm - Stainless steel
 △ 100 gr - ▷ 140 mm
Replacement jaws (2Pcs) - Ref: PINP21



Glass shipping plier
Ref: PIN001
 Stainless steel
 △ 120 gr - ▷ 145 mm

MOUNTING PLIERS



Plier to crimp plastic riders
Ref: PIN018
 «Silhouette» Type - 2 fixed nylon jaws
 Stainless steel - △ 130 gr - ▷ 145 mm
Replacement jaws - Ref: PINP18



Plier for extracting riders
Ref: PIN037
 «Silhouette» type - Stainless steel
 △ 90 gr - ▷ 135 mm



Extracting riders tool
Ref: PIN034
 Stainless steel
 △ 10 gr - ▷ 130 mm



Plier for extracting riders
Ref: PIN027
 "Silhouette" type - Stainless steel
 △ 120 gr - ▷ 150 mm
Replacement jaws - Ref: PINP27



Plier for flex templates
Ref: PIN032
 «Silhouette» type - nylon jaws -
 Stainless steel - △ 63 gr - ▷ 140 mm
Replacement jaws - Ref: PIN033



Tool stands
 available in
Working aids section



CUTTING PLIERS



Side screw cutting plier
Ref: PIN028
 Stainless steel -
 △ 100 gr - ► 165 mm



Cutting plier with locking screw
Ref: PIN010
 Nickered steel - End semi-flush cutting
 Cutting capacity: half hard mandals Ø1.2 mm
 △ 124 gr - ► 130 mm



Side cutting semi short
Ref: PIN011
 Nickered steel - end semi-flush cutting
 Cutting capacity: half hard mandal Ø1.5 mm
 △ 100 gr - ► 140 mm



Cutting plier with tilting head
Ref: PIN012
 Nickered steel, tilting head: 25°
 end semi-flush cutting -
 Cutting capacity: half hard mandal Ø1.2 mm
 △ 120 gr - ► 145 mm



Side cutting plier
Ref: PIN024
 Chromed steel - Handle in PVC
 △ 140 gr - ► 145 mm



Diagonal flush cutting plier
Ref: PIN029
 Stainless steel - With bevel
 △ 80 gr - ► 130 mm



Front cutting plier
Ref: PIN025
 Chromed steel - PVC handle
 △ 150 gr - ► 145 mm



Nylon threads
 available in
Consumables section



TWEEZERS



Straight thin tweezer
Ref: PINB04
 Stainless steel - Self-closing
 △ 30 gr - ⇄ 165 mm



Curved tweezer
Ref: PINB05
 Stainless steel - Self-closing
 △ 20 gr - ⇄ 155 mm



Cross tweezer
Ref: PINB02
 Stainless steel - Self-closing
 △ 30 gr - ⇄ 160 mm



Straight thin tweezer with jaws
Ref: PINB03
 Stainless steel
 △ 30 gr - ⇄ 150 mm



Thin tweezer
Ref: PINB01
 Stainless steel
 △ 30 gr - ⇄ 120 mm



Push-in sleeves removal
Ref: PINB08
 For «Silhouette» type - Plexiglas
 △ 10 gr - ⇄ 75 mm



Screw holding tweezer
Ref: PINB06
 Stainless steel
 △ 20 gr - ⇄ 130 mm



Curved screw holding tweezer
Ref: PINB07
 Titanium, antimagnetic, avoid solder deposits.
 △ 20 gr - ⇄ 155 mm



Screws available in the **Frame parts** section



HAND FILES



Flat hand file
Ref: LIM001
 Wooden handle
 △ 110 gr -> 290 X 3.0 mm



Smooth flat hand file
Ref: LIM002
 Wooden handle
 △ 110 gr -> 295 x 3.0 mm



Half-round hand file
Ref: LIM003
 Wooden handle
 △ 130 gr -> 295 x 3.0 mm

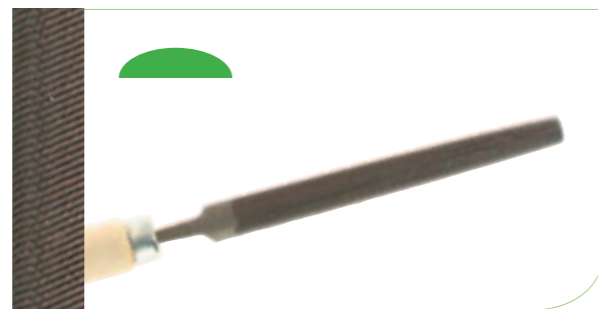

Half-round smooth file
Ref: LIM004
 Wooden handle
 △ 100 gr -> 290 X 3.0 mm



Round smooth hand file
Ref: LIM005
 Wooden handle
 △ 60 gr -> 290 X 2.5 mm

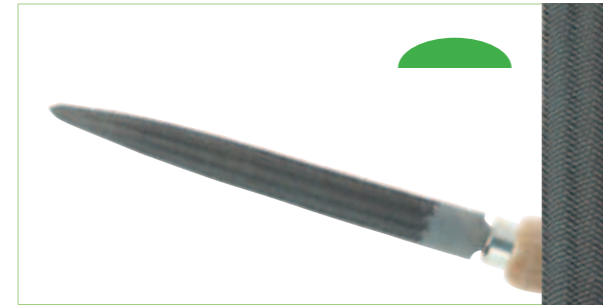

Oval hand file for plastic
Ref: LIM007
 Wooden handle - cut No. 2
 △ 47 gr -> 220 x 20 mm

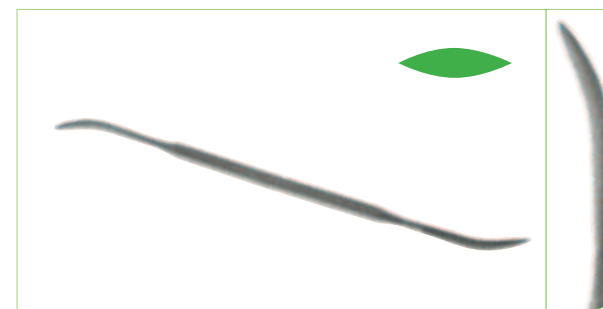

Ribbed file
Ref: LIM009
 Cut No. 2
 △ 12gr -> 150 X 4.0 mm

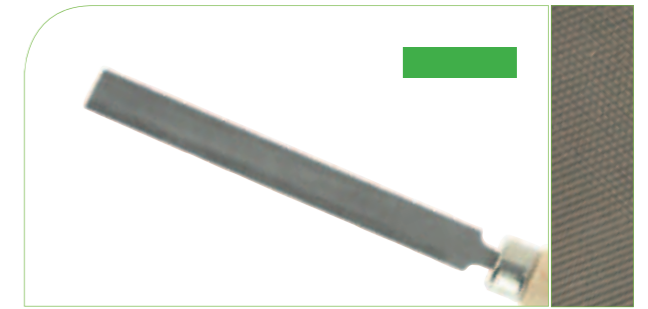

Screw hand file
Ref: LIM006
 Wooden handle - cut No. 4
 △ 25 gr -> 225 X 2.5 mm



Lenticular hand file
Ref: LIM008
 Wooden handle - cut No. 1
 △ 70 gr -> 15 x 250 x 4.0 mm



Flat hand file double cut
Ref: LIM010
 one side cut No. 0 - one side cut No. 2
 Wooden handle
 △ 60 gr -> 245 x 23 mm

File brush
Ref: CAR001
 Wooden handle
 △ 79 gr -> 250 mm

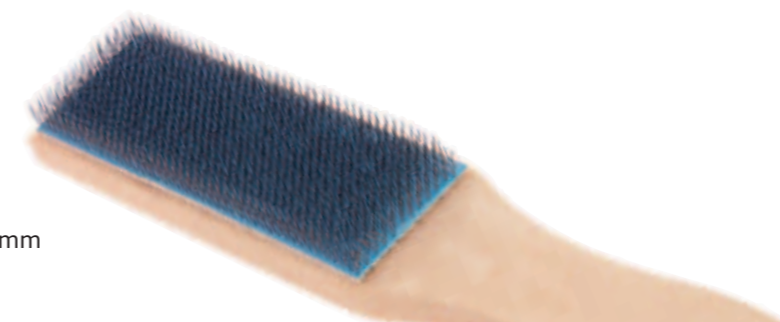

REAMERS (KNURLED HANDLE)



Set of 3 reamers

Ø1.4 mm - Ref: EQU001
△ 5 gr → 78 mm

Ø1.75 mm - Ref: EQU002
△ 5 gr → 85 mm



Set of 2 needles reamers
Ref: EQU003
Ø 0.5 mm - Ø 0.7 mm
△ 5 gr - → 85 mm

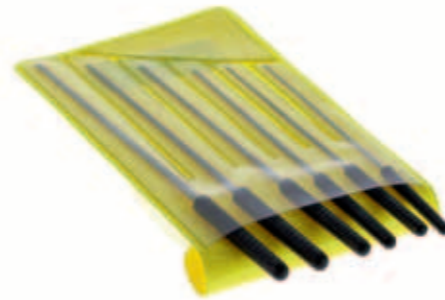

Set of 6 reamers
Ref: EQU010
Ø 1.4 to 2.1 mm
△ 17 gr → 60 x 130 mm



Saw blade
Ref: SCI016
For plastic - Set of 12
△ 5 gr → 160 mm



Saw blade
Ref: SCI013
For metal - Set of 12
△ 5 gr → 130 mm



Broach or tap holder
Ref: ROU001
Oversized wood ball handle- clamping 2.3 mm
△ 5 gr → 130 mm

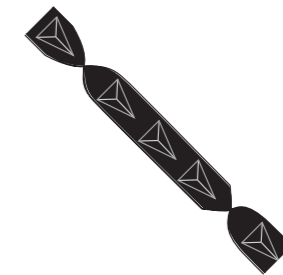

Saw blade
Ref: SCI014
Knurled - For plastic - Set of 12
△ 5 gr → 130 mm

FILES



File
Ref: LIMA01
Round, thickness : 1.3 mm
△ 13 gr → 160 mm



Set of 12 files
Ref: LIMA12
△ 110 gr → 155 mm



Set of 6 files
Ref: LIMA06
△ 5 gr → 155 mm



Broach or tap holder
Ref: ROU010
Up to Ø 0.3 mm
△ 5 gr - → 100 mm



scrapers
Ref: GRA001
3 cutting edges
Reversible and interchangeable blade
△ 5 gr → 130 mm
Replacment blade
Ref: GRA002



Saw frame
Ref: SCI001
BOCFIL type - adjustable
Black wood handle & polished steel
△ 460 gr → 200 x 265 x 14 mm

TUNGSTEN CARBIDE DRILLS AND MILLS

INDIVIDUALLY

- Strong shaft of Ø 3.175 mm.
- Length : 38 mm.
- Identification color ring.

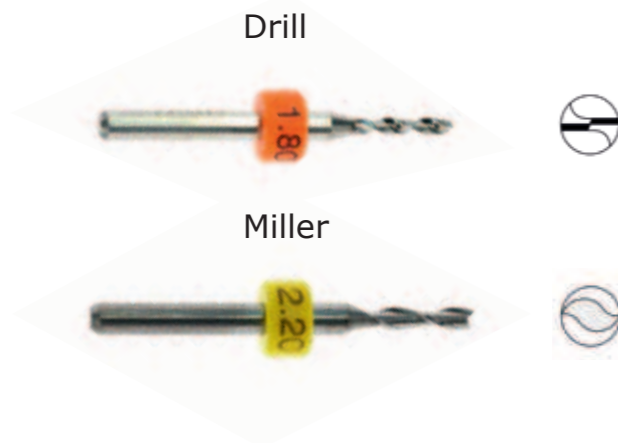

| Tungsten carbide drills and millers | | |
|-------------------------------------|--------|---------|
| DIAMETER | DRILLS | MILLERS |
| Ø 0.8 mm | FOR108 | - |
| Ø 1.0 mm | FOR110 | FRA110 |
| Ø 1.1 mm | FOR111 | FRA111 |
| Ø 1.2 mm | FOR112 | FRA112 |
| Ø 1.3 mm | FOR113 | FRA113 |
| Ø 1.4 mm | FOR114 | FRA114 |
| Ø 1.5 mm | FOR115 | FRA115 |
| Ø 1.6 mm | FOR116 | - |
| Ø 1.7 mm | FOR117 | - |
| Ø 1.8 mm | FOR118 | FRA118 |
| Ø 1.9 mm | FOR119 | FRA119 |
| Ø 2.0 mm | FOR120 | FRA120 |
| Ø 2.1 mm | FOR121 | FRA121 |
| Ø 2.2 mm | FOR122 | FRA122 |

ASSORTMENTS

Assortment of 10 drills or 10 millers with storage box.



| Drills - CFOR10 | |
|-----------------|--------|
| Ø 0.8 mm | FOR108 |
| Ø 1.0 mm | FOR110 |
| Ø 1.1 mm | FOR111 |
| Ø 1.2 mm | FOR112 |
| Ø 1.3 mm | FOR113 |
| Ø 1.4 mm | FOR114 |
| Ø 1.5 mm | FOR115 |
| Ø 1.6 mm | FOR116 |
| Ø 1.8 mm | FOR118 |
| Ø 2.0 mm | FOR120 |

| Miller - CFRA10 | |
|-----------------|--------|
| Ø 1.1 mm | FRA111 |
| Ø 1.2 mm | FRA112 |
| Ø 1.3 mm | FRA113 |
| Ø 1.4 mm | FRA114 |
| Ø 1.5 mm | FRA115 |
| Ø 1.8 mm | FRA118 |
| Ø 1.9 mm | FRA119 |
| Ø 2.0 mm | FRA120 |
| Ø 2.1 mm | FRA121 |
| Ø 2.2 mm | FRA122 |

Drill hole polishing tool - Easy Drill Réf : FTP01

Optimised drilling quality
△ 50 gr - ▷ 125 x 25 mm

HSS DRILLS AND MILLERS

Shaft of Ø 2.35 mm



Cup Ø 2.3 mm
Ref: FRAC23

Conical
Ref: FRAC30
Ø 3.0 mm - set of 2
△ 3 gr - ▷ 45 mm

Saw
Ref: FRAS23
Ø 2.3 mm - Ep : 0.2 mm
△ 3 gr - ▷ 45 mm

Biconical disk
Ref: FRAB80
Ø 8.0 mm
△ 4gr - ▷ 45 mm

Cup Ø 1.8 mm
Ref: FRAC18
Set of 2 -
△ 3 gr - ▷ 45 mm

Drills (Set of 3 Pcs)

| DIAMETER | DRILLS | DIAMETER | DRILLS |
|----------|--------|----------|--------|
| Ø 0.5 mm | FOR005 | Ø 1.3 mm | FOR013 |
| Ø 0.6 mm | FOR006 | Ø 1.4 mm | FOR014 |
| Ø 0.7 mm | FOR007 | Ø 1.5 mm | FOR015 |
| Ø 0.8 mm | FOR008 | Ø 1.6 mm | FOR016 |
| Ø 0.9 mm | FOR009 | Ø 1.7 mm | FOR017 |
| Ø 1.0 mm | FOR010 | Ø 1.8 mm | FOR018 |
| Ø 1.1 mm | FOR011 | Ø 1.9 mm | FOR019 |
| Ø 1.2 mm | FOR012 | Ø 2.0 mm | FOR020 |

SCREW TAPS - CYLINDRICAL SHAFT

Screw taps (Set of 3 Pcs)

| | |
|----------|--------|
| Ø 0.8 mm | TAR008 |
| Ø 0.9 mm | TAR009 |
| Ø 1.0 mm | TAR010 |
| Ø 1.1 mm | TAR011 |
| Ø 1.2 mm | TAR012 |
| Ø 1.3 mm | TAR013 |
| Ø 1.4 mm | TAR014 |
| Ø 1.5 mm | TAR015 |
| Ø 1.6 mm | TAR016 |
| Ø 1.7 mm | TAR017 |
| Ø 1.8 mm | TAR018 |
| Ø 1.9 mm | TAR019 |
| Ø 2.0 mm | TAR020 |



Double roller cutter for chamfering
Ref: FRS001
△ 8gr - ▷ 85 mm

SETS AND ROTATING STANDS



Wodden box for 5 handles and 7 blades- Réf : ECR001

| 5 nutdrivers handles ECRM01 | | | |
|------------------------------------|--------|--------------------|--------|
| □ | 2.2 mm | 1 square blade | ECRC01 |
| ⊕ | 2.0 mm | 1 crossblade blade | ECRC20 |
| ⊙ | 2.5 mm | 1 hexa. nutdriver | ECRE20 |
| ⊛ | 2.2 mm | 1 star blade | ECRE22 |
| ⊛ | 2.5 mm | 1 star blade | ECRE25 |
| ⊙ | 2.2 mm | 1 lhexa blade | ECRH22 |
| ⊖ | 1.5 mm | 1 blate blade | ECRP15 |



Screwdriver with conical shaft

| | | | complete screwdriver | Spare blade (x4) |
|---|--------|------------------------|----------------------|------------------|
| ⊖ | 1.6 mm | Blade screwdriver | TOUP16 | TOUL16 |
| ⊖ | 1.9 mm | Blade screwdriver | TOUP19 | TOUL19 |
| ⊕ | 1.5 mm | Crossblade screwdriver | TOUC15 | TOUL15 |
| ⊕ | 2.0 mm | Crossblade screwdriver | TOUC20 | TOUL20 |

Pocket wooden box Réf: TOUR01
WITH TOUP16 and TOUC20. △ 200 gr -> 60 x 145 x 25 mm.



Exists in two compositions

Srewdrivers set - TOU005

| | | | |
|---|--------|------------------------|--------|
| ⊖ | 1.2 mm | Blade screwdriver | TOUP10 |
| ⊖ | 1.6 mm | Blade screwdriver | TOUP15 |
| ⊖ | 1.8 mm | Blade screwdriver | TOUP18 |
| ⊕ | 1.5 mm | Crossblade screwdriver | TOU006 |
| ⊕ | 2.0 mm | Crossblade screwdriver | TOU007 |

Nutdrivers set - TOU015

| | | | |
|---|--------|-----------------|--------|
| ⊛ | 2.2 mm | Star nutdriver | ECRE12 |
| ⊛ | 2.5 mm | Star nutdriver | ECRE15 |
| ⊛ | 2.8 mm | Star nutdriver | ECRE18 |
| ⊙ | 2.2 mm | Hexa. nutdriver | ECRH12 |
| ⊙ | 2.5 mm | Hexa. nutriver | ECRH15 |



Rotating stand for screwdrivers - Réf : TOUA50

| | | | Complete screwdriver | Spare blade (x3) |
|---|--------|------------------------|----------------------|------------------|
| ⊖ | 1.0 mm | Blade screwdriver | TOUP41 | TOUP41E |
| ⊖ | 1.4 mm | Blade screwdriver | TOUP42 | TOUP42E |
| ⊖ | 1.8 mm | Blade screwdriver | TOUP43 | TOUP43E |
| ⊖ | 2.3 mm | Blade screwdriver | TOUP44 | TOUP44E |
| ⊕ | 1.5 mm | Crossblade screwdriver | TOUC41 | TOUC41E |
| ⊕ | 2.0 mm | Crossblade screwdriver | TOUC42 | TOUC42E |



Rotating stand for 9 nutdriver - Réf : TOUA51

| | | | complete nutdriver | Spare blade (x3) |
|---|--------|-------------------|--------------------|------------------|
| ⊛ | 2.0 mm | 4 stars nutdriver | ECRC42 | ECRC42E |
| ⊙ | 2.0 mm | Hexa . nutdriver | ECRH40 | ECRH40E |
| ⊙ | 2.2 mm | Hexa . nutdriver | ECRH42 | ECRH42E |
| ⊙ | 2.3 mm | Hexa . nutdriver | ECRH43 | ECRH43E |
| ⊙ | 2.6 mm | Hexa . nutdriver | ECRH46 | ECRH46E |
| ⊛ | 2.1 mm | 6 stars nutdriver | ECRE41 | ECRE41E |
| ⊛ | 2.2 mm | 6 stars nutdriver | ECRE42 | ECRE42E |
| ⊛ | 2.6 mm | 6 stars nutdriver | ECRE46 | ECRE46E |



SETS AND ROTATING STANDS



Rotating stand 9 screwdrivers & nutdrivers - TOUA10

| | | | |
|---|---------|------------------------|--------|
| ⊖ | 1.60 mm | Blade screwdriver | TOUP36 |
| ⊖ | 1.80 mm | Blade screwdriver | TOUP38 |
| ⊕ | 1.50 mm | Hexa. screwdriver | TOUC35 |
| ⊕ | 1.80 mm | Crossblade screwdriver | TOUC38 |
| ⊙ | 2.02 mm | Hexa. nutdriver | ECRH02 |
| ⊙ | 2.32 mm | Hexa. nutdriver | ECRH32 |
| ⊙ | 2.82 mm | Hexa. nutdriver | ECRH82 |
| ⊙ | 2.32 mm | Star nutdriver | ECRE52 |
| ⊙ | 2.82 mm | Star nutdriver | ECRE82 |



Mixed set - TOUA01

| | | | |
|---|--------|------------------------|--------|
| ⊖ | 1.2 mm | Blade screwdriver | TOUP10 |
| ⊖ | 1.6 mm | Blade screwdriver | TOUP15 |
| ⊖ | 1.8 mm | Blade screwdriver | TOUP18 |
| ⊖ | 2.3 mm | Blade screwdriver | TOUP23 |
| ⊕ | 1.5 mm | Crossblade screwdriver | TOU006 |
| ⊕ | 2.0 mm | Crossblade screwdriver | TOU007 |
| ⊙ | 2.2 mm | Star nutdriver | ECRE12 |
| ⊙ | 2.5 mm | Star nutdriver | ECRE15 |
| ⊙ | 2.8 mm | Star nutdriver | ECRE18 |
| ⊙ | 2.2 mm | Hexa. nutdriver | ECRH12 |
| ⊕ | 2.5 mm | Crossblade screwdriver | TOUC25 |



Essilor pocket screwdriver
Ref: TOUC90
5 heads



Universal nutdriver
Ref: ECRUNI
△ 20 gr - ▷ 80 x 15 mm

THIRD HAND



Third hand
Réf : SOU061

With 1 blade , 1 crossblade and 1 nutdriver.
△ 580 gr - ▷ 110 x 130 mm

Blades and nutdrivers for SOU061

| | | |
|---|------------------------|--------|
| ↙ | Assortment of 3 pieces | SOUL01 |
| ⊖ | Blade Ø 1.8 mm | SOUL02 |
| ⊕ | Crossblade Ø 2.0 mm | SOUL03 |
| ⊙ | Nutdriver Ø 2.2 mm | SOUC01 |

SOLDERING TOOLS



Soldering Station
Réf : SOU050

△ 13 gr - ▷ 350 x 255 mm



Third hand
Réf : SOU060

△ 590 gr - ▷ 200 x 265 mm



Flux
Réf : SOU006

Gold and silver braze for all materials.
△ 120 gr - ▷ 75 mm



Isolating paste
Réf : SOU007

Protect and isolate the solder nearest area - does not leave trace.
△ 150 gr - ▷ 150 mm

SOLDER



Warning !
Gaz oxygen transportation is regulated. It has to be packed on separated packing.

- MICROTORCH - SOU009**
- Adjustable flam 2750°C
 - Oxygen control gauge
 - Included the following accessories:
 - 6 needle tips (6,8,10 and 12/12 mm)
 - 1 distributor
 - 1 Microtorch pen
 - 1 pen stand
 - 1 gas cartridge (delivered separetely)
 - 2 oxygen canisters

MICROTORCH replacement accesories - SOU009



| Replacement needles For MICROTORCH | |
|------------------------------------|--------|
| 6/10 | SOU010 |
| 8/10 | SOU011 |
| 10/10 | SOU012 |
| 12/10 | SOU014 |



Gas cartridge
Ref: SOU015
△ 13 gr -> 3.5 x 145 mm



Oxygen canister disposable - Ref: SOU016
△ 150 gr -> 70 x 265 mm



- Mini-torch - GAM157**
- Adjustable flam 1650°C
 - Included the following accessories:
 - Burner
 - Pen torch
 - 1 disposable cartridge
- Replacement cartrigde - GAM158**
- Set of 2 cartridges for GAM157



Protection glasses
Ref: SOU033
△ 100 gr -> 195 x 60 mm



Gaz lighter
Ref: SOU034
△ 60 gr -> 195 x 40 mm



Gold solder
Ref: GAM053
Pack of 2 rolls
Ø 0.3 mm x 1.5 mm
△ 13 gr -> 90 x 45 mm



Silver solder wire Ø 0.5 mm x 2.0 m
Ref: GAM054
1 roll
Wire length : 2 meters
Melting point : 650°C
△ 22 gr -> 65 x 80 mm



Yellow solder sticks
Ref: SOU040
with fluid-Pack of 12
△ 12 gr -> 150 x 40 mm

White solder sticks
Ref: SOU041
With fluid -Pack of 12
△ 12 gr -> 150 x 40 mm



SMALL TOOLS



Bench block - rubber covered
Ref: TOU004
 △ 45 gr → 75 x 25 mm



Hammer
Ref: MAR080
 Wooden handle - Nicked head 80 mm
 △ 80 gr → 230 mm



Pointed punch
Ref: POI025
 Ø 25 mm
 △ 30 gr → 80 mm



Cup punch
Ref: BOU020
 Burnished steel Ø2.0 mm
 △ 30 gr → 80 mm



Support with screw clamp
Ref: MEN001
 Jaws of 40 mm
 Table thickness : 10 to 40 mm
 △ 20 gr → 81 x 47 mm



Joint vice
Ref: ETA001
 Jaws of 40 mm
 Table thickness : 10 to 40 mm
 △ 800 gr → 190 x 110 x 55 mm



Optician's Anvil
Ref: BIG001
 With cast base
 △ 800 gr → 130 x 110 x 90 mm



Pin punch
Ref: CHA010
 With temper pin Ø0.9 mm
 △ 20 gr → 81 x 47 mm

STAKING TOOLS



Replacement tools and accessories for Staking tools - POT001

| | | | | | | | | |
|---|-------------------------------|--------|----|---------------------------|--------|----|--------------------------|--------|
| 1 | Pointed punch | POTD01 | 8 | Single rivet setting tool | POTD08 | 15 | Single pin anvil | POTD15 |
| 2 | Pin punch | POTD02 | 9 | Double rivet setting tool | POTD09 | 16 | Double pin anvil | POTD16 |
| 3 | Peening tool for small rivets | POTD03 | 10 | Anvil holder | POTD10 | 17 | Narrow face anvil | POTD17 |
| 4 | Peening tool for large rivets | POTD04 | 11 | Round hole anvil | POTD11 | 18 | Base pin for POTD17 | POTD18 |
| 5 | Single piercing punch Ø1.2 mm | POTD05 | 12 | Oval hole anvil | POTD12 | 19 | Piercing punch extractor | POTD19 |
| 6 | Double piercing punch Ø1.2 mm | POTD06 | 13 | Solid anvil steel | POTD13 | | | |
| 7 | Pins Ø1.2 mm (10Pcs) | POTD07 | 14 | Solid anvil nylon | POTD14 | | | |

MEASURING TOOLS



Tracing compass
Ref: COM075
 Polished steel.
 Quick aperture system
 Max. aperture : Ø 75 mm
 △ 87 gr - ▯ 140 mm



Pliable thread-counter
Ref: CFE000
 Polished steel
 x8 graduated magnifying glass



Thickness gauge
Ref: COM002
 Aperture from 0 to 10 mm
 Arm depth 45 mm and precision 0.5 mm
 △ 160 gr - ▯ 137 x 85 x 37 mm



Lens clock
Ref: SPH001
 △ 150 gr - ▯ 135 x 85 mm



Pantoscopic angle
Ref: RAP210
 △ 21 gr - ▯ 70 x 70 x 9 mm

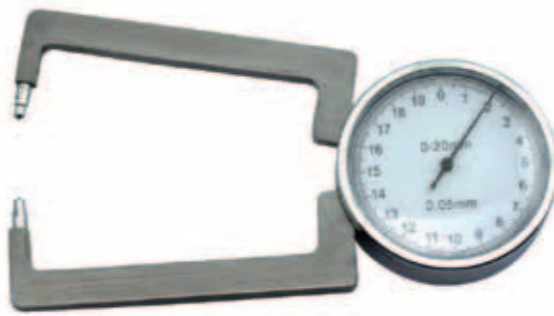

Thickness gauge
Ref: COM003
 Aperture from 0 to 20 mm
 Arm depth 80 mm and precision 0.5 mm
 △ 374 gr - ▯ 180 x 110 x 35 mm



Caliper gauge 1/50e
Ref: PIE001
 Inner, external and depth
 △ 30 gr - ▯ 240 x 90 mm



Caliper gauge 1/100e
Ref: PIE002
 Digital
 △ 30 gr - ▯ 240 x 90 mm



Angle measuring device
Ref: RAP200
 Stainless steel - Angle of 95 mm,
 Degree graduation
 △ 8 gr - ▯ 210 x 85 mm



Metal ruler
Ref: REG200
 Stainless steel,
 △ 4 gr - ▯ 200 mm

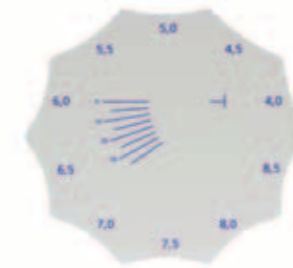

Lens base checking tool
Réf : JAU001
 Easy measure of the lens bases
 from 4 to 8.5.
 △ 60 gr - ▯ 180 mm



Drilling gauge
Réf : JAU002
 Easy check of the drilling holes diameter
 from 1 to 2.2 mm
 △ 15 gr - ▯ 65 x 7 mm





Large composition suitcase
Ref: MAL001

40 articles listed as below:



Large composition suitcase

| | | | |
|------------------------------|---------|---------------------------------|---------|
| 1 storage box 12 cases | BOI002 | 1 set of 3 drill bits Ø 1.4 mm | FOR014 |
| 1 cup punch ø 2 mm | BOU020* | 1 scraper | GRA001* |
| 1 straight thin tweezer | PINB04 | 1 set of 6 needle files | LIMA06* |
| 1 tweezer - pointed | PINB01* | 1 flat hand file 150 mm | LIM001* |
| 1 file brush | CAR01* | 1 smooth flat hand file 150 mm | LIM002* |
| 1 pin punch ø 1 mm | CHA010* | 1 half-round smooth file 150 mm | LIM004 |
| 1 tracing compass 75 mm | COM075* | 1 round smooth hand file 150 mm | LIM005* |
| 1 set of 6 reamers | EQU010 | 1 screw head file | LIM006 |
| 1 set of 3 drill bits ø 1 mm | FOR010 | 1 hammer | MAR080* |
| 1 set of drill bit ø 1.2 mm | FOR012* | 1 set of saw blades metal (dze) | SCI013* |
| 1 caliper gauge 1/20 150 mm | PIE001* | | |



Small composition suitcase
Ref: MAL002

30 articles pointed out with *
in the following list:



Small composition suitcase*

| | | | |
|-----------------------------------|---------|------------------------------|---------|
| 1 saw frame 150 mm | SCI001* | 1 center punch Ø 2.5 mm | POI025* |
| 1 set of saw blades plastic (dze) | SCI016* | 1 metal ruler 200 mm | REG200* |
| 1 glass shipping plier | PIE001* | 1 broach holder | ROU010* |
| 1 forming plier | PIN002* | 1 set of 3 screw taps 1 mm | TAR010 |
| 1 inclination conical plier | PIN004* | 1 set of 3 screw taps 1.2 mm | TAR012 |
| 1 angling plier | PIN007* | 1 set of 3 screw taps 1.4 mm | TAR014 |
| 1 diagonale cutting plier | PIN011 | 1 universal nut driver | ECRUNI* |
| 1 half round long nose plier | PIN016* | 1 screwdrivers blade 1.9 mm | TOUP19* |
| 1 trace tip | POI001* | 1 PVC suitcase with code | MAL010* |
| 1 carbide tracer KYTRASS | POI003* | 1 protection glasses | LUN001* |





FRAME PARTS

| | |
|--------------------------------------------------|------|
| NOSE PADS | 3-2 |
| NOSE BRIDGES - PAD ARMS - NYLON THREADS | 3-6 |
| SCREWS | 3-8 |
| SCREWS - RIMLESS PARTS | 3-12 |
| NUTS - WASHERS - DOME NUTS RIM LOCKS | 3-14 |
| HINGES | 3-16 |
| HINGES - TEMPLES | 3-18 |
| TEMPLES | 3-20 |
| TEMPLES - TEMPLES ENDS | 3-22 |
| TEMPLE ENDS - SPECTACLE CORDS - ASSORT- MENTS | 3-24 |
| THE ESSENTIALS ASSORTMENTS | 3-26 |

SILICONE WITH PLASTIC INSERT – COMFORTABLE FIT



50 Pairs

SYMMETRICAL

| | | | | | |
|--|----------|-------|---------|---------|---------|
| | Push in | 9 mm | 10.5 mm | | |
| | Screw in | | | NPSS01 | NPSS03 |
| | Push in | 11 mm | 13 mm | 14.5 mm | 16.5 mm |
| | Screw in | | | NPSS02 | NPSS04 |
| | Push in | | | NPSS05 | NPSS07 |
| | Screw in | | | NPSS06 | NPSS08 |
| | Push in | 11 mm | 13 mm | 14.5 mm | 17 mm |
| | Screw in | | | NPSS09 | NPSS11 |
| | Push in | | | NPSS10 | NPSS12 |
| | Screw in | | | NPSS13 | NPSS15 |
| | Push in | | | NPSS17 | NPSS19 |
| | Screw in | | | NPSS14 | NPSS16 |
| | Push in | | | NPSS18 | NPSS20 |
| | Screw in | | | | |

D-SHAPE

| | | | | |
|--|----------|-------|---------|-------|
| | Push in | 13 mm | 14.5 mm | 17 mm |
| | Screw in | | | |
| | Push in | | | |
| | Screw in | | | |
| | Push in | | | |
| | Screw in | | | |
| | Push in | | | |
| | Screw in | | | |

ULTRA SLIM, SYMMETRICAL

| | | |
|--|----------|---------|
| | Push in | 12.5 mm |
| | Screw in | |
| | Push in | 12.5 mm |
| | Screw in | |
| | Push in | 15 mm |
| | Screw in | |
| | Push in | |
| | Screw in | |
| | Push in | |
| | Screw in | |

SILICONE WITH PLASTIC INSERT – COMFORTABLE FIT

AIR PAD CUSHION, SYMMETRICAL



10 Pairs

| | | | | |
|--|----------|---------|--------|--------|
| | Push in | 13.5 mm | 14 mm | 16 mm |
| | Screw in | | | |
| | Push in | - | NPSA02 | - |
| | Screw in | NPSA01 | - | NPSA03 |

MUSHROOM TYPE, SYMMETRICAL



50 Pairs

| | | | | |
|--|----------|---------|---------|---------|
| | Push in | 8.5 mm | 11 mm | |
| | Screw in | | | |
| | Push in | | | |
| | Screw in | | | |
| | Push in | 11 mm | 12.5 mm | 14.5 mm |
| | Screw in | | | |
| | Push in | | | |
| | Screw in | | | |
| | Push in | 10.5 mm | | |
| | Screw in | | | |

SADDLE BRIDGES



5 Pcs

| | | | |
|----------|------------|-------------|-------------|
| | Small type | Junior type | Medium type |
| | 19 mm | 15 mm | 14 mm |
| | 19.5 mm | 32 mm | 44 mm |
| Push in | NPSB01 | Push in | NPSB03 |
| Screw in | NPSB02 | Screw in | NPSB04 |
| Push in | | Push in | NPSB05 |
| Screw in | | Screw in | NPSB06 |

SILICONE CUSHIONS SELF ADHESIVE

20 Pcs  0.7mm









| | | | | |
|-----------------------------------------------------------------------------------|--------|--------|--------|--------|
|  | 13 mm | 15 mm | 17 mm | 19 mm |
| | NPC001 | NPC002 | NPC003 | NPC004 |



POLYCARBONATE ULTRA SLIM, LONG-LASTING, DURABLE



50 Pairs 

SYMMETRICAL

| | |
|---------------------------------------------------------------------------------------------|--------|
|  | 9 mm |
| Push in  | NPPS25 |
| Screw in  | NPPS26 |

| | |
|----------------------------------------------------------------------------------------------|---------|
|  | 12.5 mm |
| Push in  | NPPS27 |
| Screw in  | NPPS28 |



| | |
|----------------------------------------------------------------------------------------------|--------|
|  | 12 mm |
| Push in  | NPPS29 |
| Screw in  | NPPS30 |



| | |
|----------------------------------------------------------------------------------------------|--------|
|  | 13 mm |
| Push in  | NPPS31 |
| Screw in  | NPPS32 |

PVC WITH PLASTIC INSERT - SOFT FIT

50 Pairs - **Phthalate Free!** 

SYMMETRICAL

| | |
|----------------------------------------------------------------------------------------------|--------|
|  | 9 mm |
| Push in  | NPPS01 |
| Screw in  | NPPS02 |

| | | | |
|----------------------------------------------------------------------------------------------|---------|--------|--------|
|  | 12.5 mm | 15 mm | 17 mm |
| Push in  | NPPS03 | NPPS05 | NPPS07 |
| Screw in  | NPPS04 | NPPS06 | NPPS08 |

| | | |
|----------------------------------------------------------------------------------------------|---------|---------|
|  | 12.5 mm | 14.5 mm |
| Push in  | NPPS09 | NPPS11 |
| Screw in  | NPPS10 | NPPS12 |

D-SHAPE



| | | | |
|------------------------------------------------------------------------------------------------|--------|---------|---------|
|  | 13 mm | 14.5 mm | 16.5 mm |
| Push in  | NPPD01 | NPPD03 | NPPD05 |
| Screw in  | NPPD02 | NPPD04 | NPPD06 |

PVC TRANSPARENT WITH METAL INSERT - SEMI RIGID

25 Pairs 

SYMMETRICAL

| | | | |
|------------------------------------------------------------------------------------------------|--------|--------|--------|
|  | 12 mm | 15 mm | 17 mm |
| Push in  | NPPS14 | NPPS18 | NPPS22 |
| Screw in  | NPPS16 | NPPS20 | NPPS24 |

| | | | |
|------------------------------------------------------------------------------------------------|--------|--------|--------|
|  | 12 mm | 15 mm | 17 mm |
| Push in  | NPPS13 | NPPS17 | NPPS21 |
| Screw in  | NPPS15 | NPPS19 | NPPS23 |

B+L STYLE, CLIP-ON

| | |
|----------------------------------------------------------------------------------------------|---------|
|  | 15.5 mm |
| Silver  | NPPS33 |
| Gold  | NPPS34 |

SILICONE NOSE BRIDGE WITH METAL INSERT

5 Pcs with 10 Pcs of fitting screws

| | |
|--------|---------|
| | 14.7 mm |
| Silver | NBS001 |
| | |
| Gold | NBS002 |
| | 16.5 mm |
| Silver | NBS003 |
| | |
| Gold | NBS004 |
| | 17.5 mm |
| Silver | NBS005 |
| | |
| Gold | NBS006 |

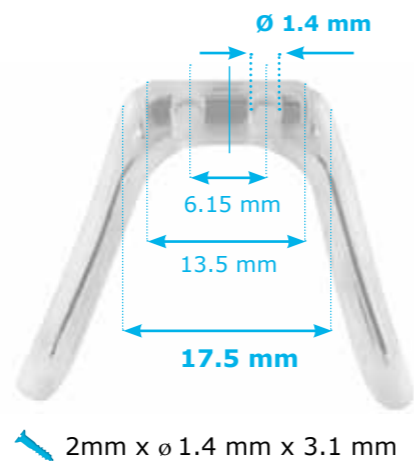
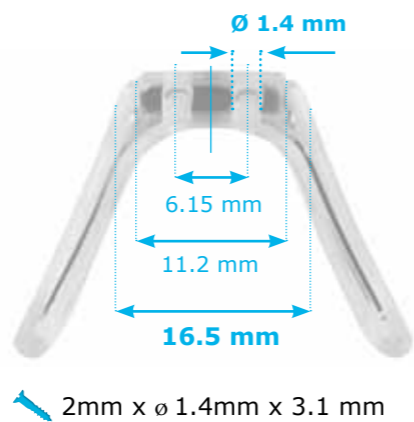
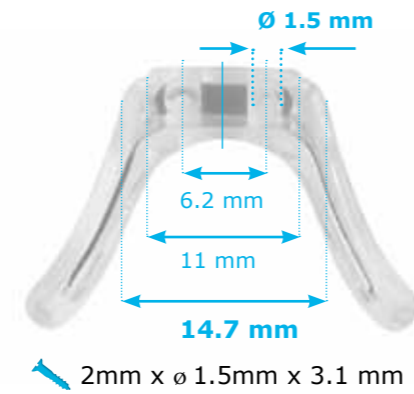

PAD ARMS FOR METAL FRAMES - NICKEL FREE

5 Pairs

STANDARD TYPE

| | | | |
|------|--------|------|--------|
| | PAM002 | | PAM004 |
| Gold | PAM001 | Gold | PAM003 |

B+L STYLE (CLIP ON)

| | |
|------|--------|
| | PAM006 |
| Gold | PAM005 |

NYLON THREADS

8 SHAPE

10M/roll



FDR003

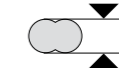

0.55 mm

T SHAPE

5M/roll



FDR004



1.3 mm



FDR005



2.0 mm

ROUND

20M/roll



FDR006

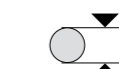

0.5 mm



FDR007

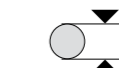

0.6 mm

A COMPREHENSIVE SET OF NYLON THREADS THAT CATER FOR BASIC NEEDS



| FDR101 | |
|----------|----------------|
| 10M/roll | 0.55 mm FDR003 |
| 5M/roll | 1.3 mm FDR004 |
| 5M/roll | 2.0 mm FDR005 |
| 20M/roll | 0.5 mm FDR006 |
| 20M/roll | 0.6 mm FDR007 |

CYREX NYLON THREADS

Acetate



4.4 M/roll



0.25 mm

FDR001



2.7 M/roll



0.5 mm

























FDR002

RIM JOINT SCREWS

 100 Pcs

STAINLESS STEEL













































| | | | | | |
|-------------------------------------------------------------------------------------|--------|-------------------------------------------------------------------------------------|--------|--------|--------|
|  | SCR001 |  | 1.6 mm | 1.2 mm | 3.2 mm |
|  | SCR002 |  | 1.6 mm | 1.2 mm | 4.7 mm |
|  | SCR003 |  | 1.8 mm | 1.3 mm | 7 mm |
|  | SCR004 |  | 1.8 mm | 1.4 mm | 3.9 mm |
|  | SCR005 |  | 1.8 mm | 1.4 mm | 5.2 mm |
|  | SCR006 |  | 2.0 mm | 1.4 mm | 4.3 mm |
|  | SCR007 |  | 1.8 mm | 1.5 mm | 5.2 mm |
|  | SCR008 |  | 1.8 mm | 1.5 mm | 5.2 mm |
|  | SCR009 |  | 1.8 mm | 1.5 mm | 5.2 mm |
|  | SCR010 |  | 1.8 mm | 1.5 mm | 5.2 mm |
|  | SCR011 |  | 2.0 mm | 1.4 mm | 4.3 mm |
|  | SCR012 |  | 2.0 mm | 1.4 mm | 4.3 mm |
|  | SCR013 |  | 1.8 mm | 1.5 mm | 5.2 mm |

SELF ALIGNING SCREWS FOR SPRING HINGES

 100 Pcs

STAINLESS STEEL



| | | | | | | |
|---------------------------------------------------------------------------------------|--------|---------------------------------------------------------------------------------------|--------|--------|--------|--------|
|  | SCA001 |  | 1.4mm | 1.0mm | 5.8mm | 2.8mm |
|  | SCA002 |  | 2.0mm | 1.2mm | 5.9mm | 3.5mm |
|  | SCA003 |  | 2.0mm | 1.2mm | 5.9mm | 3.5mm |
|  | SCA004 |  | 2.0mm | 1.2mm | 5.9mm | 3.5mm |
|  | SCA005 |  | 2.0mm | 1.3mm | 6.5mm | 3.5mm |
|  | SCA006 |  | 2.0mm | 1.3mm | 6.5mm | 3.5mm |
|  | SCA007 |  | 2.0 mm | 1.4 mm | 6.5mm | 2.5mm |
|  | SCA019 |  | 2.0 mm | 1.4 mm | 6.5 mm | 3.5 mm |
|  | SCA020 |  | 2.0 mm | 1.4 mm | 6.5 mm | 3.5 mm |
|  | SCA021 |  | 2.0 mm | 1.4 mm | 7.0 mm | 4.0 mm |
|  | SCA008 |  | 2.0 mm | 1.4 mm | 7.0 mm | 4.0 mm |
|  | SCA009 |  | 2.0 mm | 1.4 mm | 7.8 mm | 4.8 mm |
|  | SCA010 |  | 2.0 mm | 1.4 mm | 7.8 mm | 4.8 mm |
|  | SCA011 |  | 2.0 mm | 1.5 mm | 6.5 mm | 3.5 mm |
|  | SCA012 |  | 2.0 mm | 1.5 mm | 6.5 mm | 3.5 mm |
|  | SCA013 |  | 2.0 mm | 1.6 mm | 6.5 mm | 3.5 mm |
|  | SCA014 |  | 2.0 mm | 1.6 mm | 6.5 mm | 3.5 mm |
|  | SCA015 |  | 2.0 mm | 1.6 mm | 6.5 mm | 3.5 mm |
|  | SCA016 |  | 2.0 mm | 1.6 mm | 6.5 mm | 3.5 mm |
|  | SCA017 |  | 2.0 mm | 1.6 mm | 6.5 mm | 3.5 mm |
|  | SCA018 |  | 2.0 mm | 1.6 mm | 6.5 mm | 3.5 mm |

HINGE SCREWS

 Steel - 100 Pcs

STAINLESS STEEL

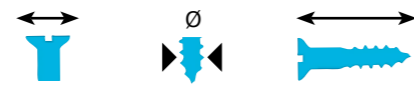

| Image | Code | Symbol | Head Diameter | Head Height | Thread Length |
|-------|--------|--------|---------------|-------------|---------------|
| | SCH001 | ⊖ | 1.6 mm | 1.2 mm | 4.8 mm |
| | SCH002 | ⊖ | 1.7 mm | 1.3 mm | 5.3 mm |
| | SCH003 | ⊖ | 2.0 mm | 1.4 mm | 2.7 mm |
| | SCH004 | ⊖ | 2.0 mm | 1.4 mm | 2.7 mm |
| | SCH005 | ⊖ | 1.8 mm | 1.4 mm | 4.2 mm |
| | SCH006 | ⊖ | 1.8 mm | 1.4 mm | 4.2 mm |
| | SCH007 | ⊖ | 1.8 mm | 1.4 mm | 5.0 mm |
| | SCH008 | ⊖ | 1.8 mm | 1.4 mm | 5.0 mm |
| | SCH009 | ⊖ | 2.8 mm | 1.4 mm | 8.6 mm |
| | SCH010 | ⊖ | 2.8 mm | 1.4 mm | 11.4 mm |
| | SCH011 | ⊖ | 1.8 mm | 1.5 mm | 5.0 +mm |
| | SCH012 | ⊖ | 1.8 mm | 1.5 mm | 5.0 +mm |
| | SCH013 | ⊖ | 2.8 mm | 1.5 mm | 10.0 mm |
| | SCH014 | ⊖ | 1.8 mm | 1.6 mm | 5.2 mm |
| | SCH015 | ⊖ | 1.8 mm | 1.6 mm | 5.2 mm |
| | SCH016 | ⊖ | 2.8 mm | 1.6 mm | 9.0 mm |

NOSE PAD SCREWS

 100 Pcs

STAINLESS STEEL

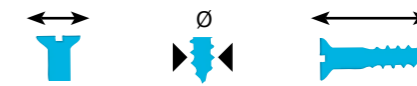

| Image | Code | Symbol | Head Diameter | Head Height | Thread Length |
|-------|--------------------------------------|--------|---------------|-------------|---------------|
| | SCN001 | ⊖ | 1.0 mm | 0.8 mm | 3.7 mm |
| | SCN002 | ⊕ | 1.8 mm | 1.0 mm | 3.8 mm |
| | SCN003 | ⊕ | 1.8 mm | 1.0 mm | 3.8 mm |
| | SCN004 | ⊖ | 1.2 mm | 1.0 mm | 4.0 mm |
| | SCN005 | | | | |
| | SCN006 | | | | |
| | SCN007 | ⊖ | 1.4 mm | 1.0 mm | 4.0 mm |
| | SCN008 | | | | |
| | *With stay tight thread lock coating | | | | |
| | SCN009 | ⊖ | 1.4 mm | 1.0 mm | 4.45 mm |
| | SCN010 | ⊖ | 1.3 mm | 1.1 mm | 4.2 mm |

SELF-TAPPING SCREWS WITH TRANSPARENT SECURER

 50 Pcs



















STAINLESS STEEL

| Image | Code | Symbol | Head Diameter | Head Height | Thread Length |
|-------|--------|--------|---------------|-------------|---------------|
| | SCT001 | ⊖ | 1.8 mm | 1.3 mm | 11.5 mm |
| | SCT002 | ⊖ | 1.8 mm | 1.3 mm | 11.5 mm |
| | SCT003 | ⊖ | 1.8 mm | 1.4 mm | 11.5 mm |
| | SCT004 | ⊖ | 1.8 mm | 1.4 mm | 11.5 mm |
| | SCT005 | ⊖ | 1.8 mm | 1.5 mm | 11.5 mm |
| | SCT006 | ⊖ | 1.8 mm | 1.5 mm | 11.5 mm |

RIMLESS FRAME SCREWS

 Steel - 100 Pcs



STAINLESS STEEL

| | |  |  |  |
|-------------------------------------------------------------------------------------|--------|-----------------------------------------------------------------------------------|-----------------------------------------------------------------------------------|------------------------------------------------------------------------------------|
|  | SCF001 | ⊖ | 1.8 mm | 15.0 mm |
|  | SCF002 | | | |
|  | SCF003 | ⊕ | 2.5 mm | 10.7 mm |
|  | SCF004 | | | |
|  | SCF005 | ⊖ | 2.5 mm | 12.0 mm |
|  | SCF006 | | | |
|  | SCF007 | ⊙ | 2.5 mm | 12.6 mm |
|  | SCF008 | | | |
|  | SCF009 | ⊖ | 1.8 mm | 15.0 mm |
|  | SCF010 | | | |
|  | SCF011 | ⊖ | 2.5 mm | 12.0 mm |
|  | SCF012 | | | |
|  | SCF013 | ⊙ | 2.5 mm | 12.6 mm |
|  | SCF014 | | | |
|  | SCF015 | | | |

RIMLESS CAPS

 100 Pcs





PLASTIC, TRANSPARENT

| | | | | |
|-------------------------------------------------------------------------------------|--------|----------|--------|--------|
|  | SLR016 | ∅ 2.5 mm | 1.2 mm | 3.5 mm |
|  | SLR017 | ∅ 3.0 mm | 1.4 mm | 3.5 mm |



DOUBLE SLEEVES FOR RIMLESS FRAMES

 50 Pcs



PLASTIC SOFT MATERIAL

| | | |
|-------------------------------------------------------------------------------------|--------|----------|
|  | SLR004 | |
|  | SLR005 | ∅ 1.4 mm |
|  | SLR006 | |
|  | SLR010 | ∅ 1.8 mm |

PLASTIC HARD MATERIAL

| | | |
|-------------------------------------------------------------------------------------|--------|----------|
|  | SLR007 | ∅ 1.4 mm |
|  | SLR008 | ∅ 1.5 mm |
|  | SLR011 | ∅ 1.8 mm |

PLASTIC MEDIUM SOFT MATERIAL

| | | |
|-------------------------------------------------------------------------------------|--------|----------|
|  | SLR003 | ∅ 1.3 mm |
|  | SLR009 | ∅ 1.5 mm |

PLASTIC HARD MATERIAL

| | | |
|-------------------------------------------------------------------------------------|--------|----------|
|  | SLR012 | ∅ 1.5 mm |
|  | SLR013 | ∅ 1.8 mm |

CUPRONICKEL RIVETS

 50 Pcs

DOUBLE

| | | | | |
|---------------------------------------------------------------------------------------|--------|-----------|--------|--------|
|  | SLR015 | ∅ 1.05 mm | 2.5 mm | 8.7 mm |
|---------------------------------------------------------------------------------------|--------|-----------|--------|--------|





SINGLE

| | | | | |
|---------------------------------------------------------------------------------------|--------|-----------|---|-------|
|  | SLR014 | ∅ 1.18 mm | - | 10 mm |
|---------------------------------------------------------------------------------------|--------|-----------|---|-------|

PLASTIC SLEEVES FOR RIMLESS FRAMES

 100 Pcs

















PLASTIC TRANSPARENT

| | |  |  |
|---------------------------------------------------------------------------------------|--------|---------------------------------------------------------------------------------------|---------------------------------------------------------------------------------------|
|  | SLR001 | 2.8 mm | 1.2 mm |
|  | SLR002 | 2.8 mm | 1.4 mm |

NUTS

 Brass - 100 Pcs

BRASS

| | |  |  |
|-------------------------------------------------------------------------------------|--------|-------------------------------------------------------------------------------------|------------------------------------------------------------------------------------|
|  | NRS001 | | |
|  | NRS002 |  | 2.5 mm 1.2 mm |
|  | NRS003 | | |
|  | NRS004 |  | 2.5 mm 1.3 mm |
|  | NRS005 | | |
|  | NRS006 |  | 2.5 mm 1.4 mm |
|  | NRS007 | | |
|  | NRS008 |  | 2.5 mm 1.5 mm |
|  | NRS009 |  | 2.5 mm 1.6 mm |

WASHERS

 Brass - 100 Pcs





BRASS

| | |  |  |
|-------------------------------------------------------------------------------------|--------|-------------------------------------------------------------------------------------|--------------------------------------------------------------------------------------|
|  | WAS001 | | |
|  | WAS002 | | 2.5 mm 1.2 mm |
|  | WAS003 | | |
|  | WAS004 | With conical head | 2.8 mm 1.2 mm |
|  | WAS006 | | |
|  | WAS007 | | 2.5 mm 1.4 mm |
|  | WAS008 | | |
|  | WAS009 | *with conical head | 2.8mm 1.4 mm |

WASHERS

 100 Pcs

PLASTIC TRANSPARENT

| | |  |  |
|-------------------------------------------------------------------------------------|--------|-------------------------------------------------------------------------------------|-------------------------------------------------------------------------------------|
|  | WAS005 | 2.5mm | 1.2mm |
|  | WAS010 | 2.8mm | 1.4mm |



DOME NUTS

 100 Pcs

BRASS

| | |  |  |
|---------------------------------------------------------------------------------------|--------|---------------------------------------------------------------------------------------|-------------------------------------------------------------------------------------|
|  | NRH001 | | |
|  | NRH002 |  | 2.4 mm 1.2 mm |
|  | NRS010 | | |
|  | NRS011 |  | 2.4 mm 1.2 mm |
|  | NRH003 | | |
|  | NRH004 |  | 2.4 mm 1.4 mm |
|  | NRS012 | | |
|  | NRS013 |  | 2.4 mm 1.4 mm |
|  | NRS014 | | |

RIM LOCKS



 10 Pcs + 10 



| | |  |  |  |
|---------------------------------------------------------------------------------------|--------|---------------------------------------------------------------------------------------|---------------------------------------------------------------------------------------|---------------------------------------------------------------------------------------|
|  | HRL001 | 1.4 mm | 2.4 mm | 4.0 mm |
|  | HRL002 | 1.4 mm | 2.4 mm | 4.5 mm |





SOLDER HINGES



10 Pcs  1.4 mm

- *  HS0001
Left Front Part
- *  HS0002
Right Front part
-  HS0003
Temple Front Part

- *  HS0004
Left Front Part*
- *  HS0005
Right Front part*
-  HS0006
Temple Front Part

- *  HS0007
For Flex Sides, Left*
- *  HS0008
For Flex Sides, Right*

- *  HS0009
For Flex Sides, Left*
- *  HS0010
For Flex Sides, Right*





- *  HS0011
Left Front Part*
- *  HS0012
Right Front part*
-  HS0013
Temple Front Part









*10 Pcs +10  included





PINNED HINGES

10 Pcs  2.5 mm  1.4 mm  2.5 mm  1.2 mm

- *  HP0001
Left Temple Part*
- *  HP0002
Right Temple Part*
-  HP0003
Left Front Part
-  HP0004
Right Front Part

- *  HP0005
Left Temple Part*
- *  HP0006
Right Temple Part*
-  HP0007
Front Part

- *  HP0008
Left Temple Part*
- *  HP0009
Right Temple Part*
-  HP0010
Left Front Part
-  HP0011
Right Front Part

- *  HP0012
Left Temple Part*
- *  HP0013
Right Temple Part*
-  HP0014
Left Front Part
-  HP0015
Right Front Part

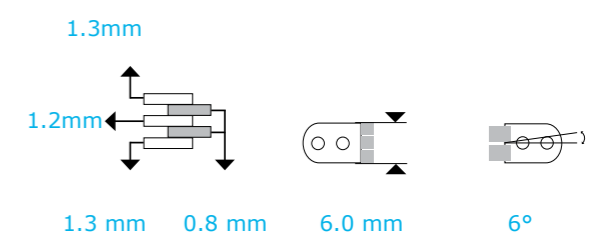
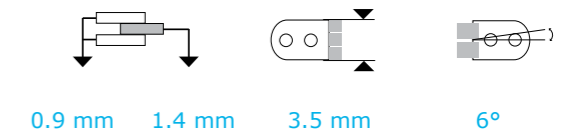
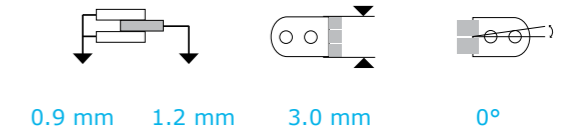
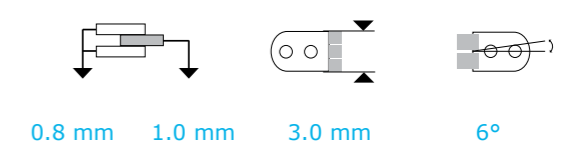































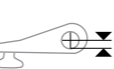





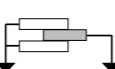







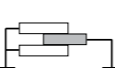





*10 Pcs +10  included

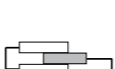

HIDDEN HINGES

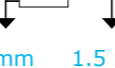
10 Pcs  1.4 mm





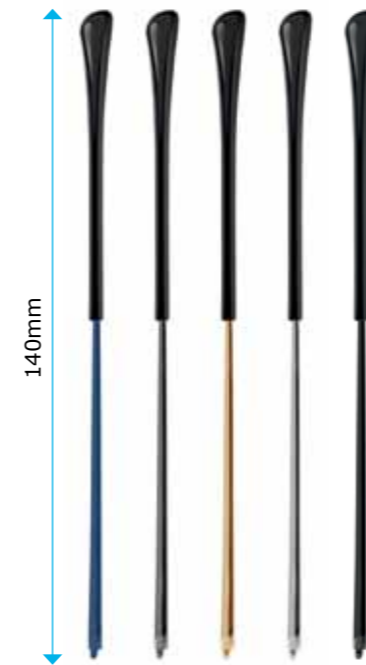

| | | | | | |
|-------------------------------------------------------------------------------------|----------------------------------------------|-------------------------------------------------------------------------------------|--------------------------------------------------------------------------------------|---------------------------------------------------------------------------------------|-----------------------------|
|  | HH0001 Round Plate |  |  |  | 1.0 mm 5.0 mm 2.5 mm |
|  | HH0002 Round Plate |  |  |  | 1.2 mm 5.0 mm 2.5 mm |
|  | HH0003 Round Plate |  |  |  | 1.4 mm 5.0 mm 2.5 mm |
|  | HH0004 Oval Plate with Nylon Insert |  |  |  | 1.3 mm 4.4 mm 3.2 mm |
|  | HH0005 Square Plate |  |  |  | 1.4 mm 3.5 mm 2.24 mm |
|  | HH0006 For Front or Temple |  |  |  | 1.6 mm 3.5 mm 3.15 mm |
|  | HH0007 Oval Plate |  |  |  | 1.6 mm 7.0 mm 3.2 mm |
|  | * HH0008 For Flexible joint Sides, Left* |  |  |  | 0.8 mm 1.2 mm 2.8 mm 3.2 mm |
|  | * HH0009 For Flexible joint Sides, Right* |  |  |  | 0.8 mm 1.2 mm 2.8 mm 3.2 mm |
|  | * HH0010 For Flexible joint Sides, Left* |  |  |  | 0.9 mm 1.2 mm 3.3 mm 0.6 mm |
|  | * HH0011 For Flexible joint Sides, Right* |  |  |  | 0.9 mm 1.2 mm 3.3 mm 0.6 mm |
|  | * HH0012 For Flexible joint Sides, Left* |  |  |  | 1.0 mm 1.5 mm 4.5 mm 3.2 mm |
|  | * HH0013 For Flexible joint Sides, Right* |  |  |  | 1.0 mm 1.5 mm 4.5 mm 3.2 mm |

*10 Pcs +10  included

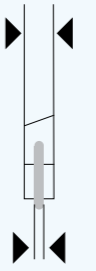
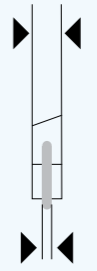
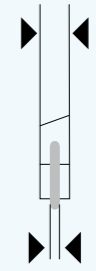
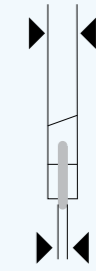
METAL TEMPLES

1 pair  ø1.4 mm



| | 3.6 mm | 3.2 mm | 2.5 mm | 2.5 mm |
|--------------------------------------------------------------------------------------|-------------------------------------------------------------------------------------|-------------------------------------------------------------------------------------|-------------------------------------------------------------------------------------|-------------------------------------------------------------------------------------|
|  |  |  |  |  |
| 140 mm | 1.4 mm | 1.2 mm | 1.0 mm | 0.8 mm |
|  | TM0020 | TM0015 | TM0010 | TM0005 |
|  | TM0019 | TM0014 | TM0009 | TM0004 |
|  | TM0018 | TM0013 | TM0008 | TM0003 |
|  | TM0017 | TM0012 | TM0007 | TM0002 |
|  | TM0016 | TM0011 | TM0006 | TM0001 |



| 145 mm | |
|---------------------------------------------------------------------------------------|--------|
|  | TM0021 |
|  | TM0022 |
|  | TM0023 |

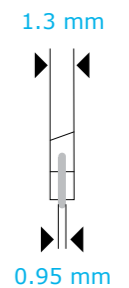







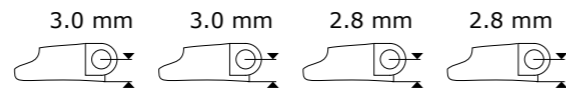

 NICKEL FREE!

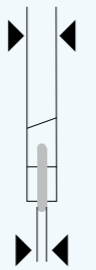
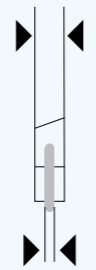
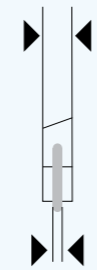
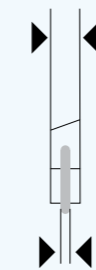

METAL FLEX TEMPLES







1 pair  $\phi 1.4$ mm **Anti-Allergy!**

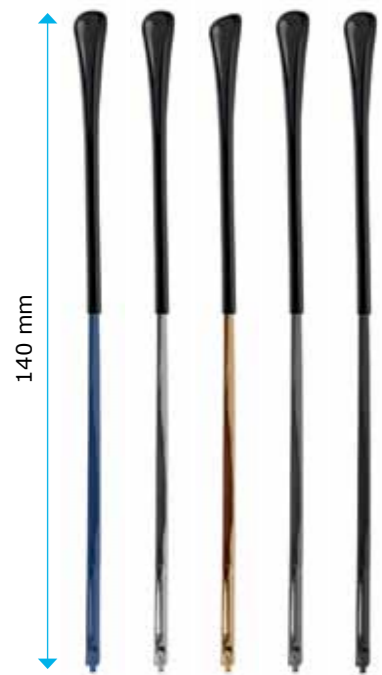

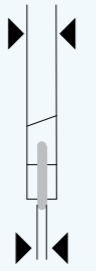
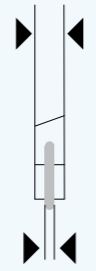
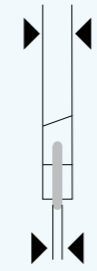
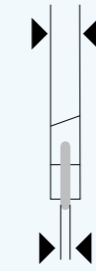
| | 3.5 mm | 3.5 mm | 3.3 mm | 3.3 mm |
|-----------------------------------------------------------------------------------|-----------------------------------------------------------------------------------|-----------------------------------------------------------------------------------|-------------------------------------------------------------------------------------|-------------------------------------------------------------------------------------|
|  |  |  |  |  |
| | 1.4 mm | 1.2 mm | 1.0 mm | 0.8 mm |
|  | TMF041 | TMF036 | TMF031 | TMF026 |
|  | TMF042 | TMF037 | TMF032 | TMF027 |
|  | TMF043 | TMF038 | TMF033 | TMF028 |
|  | TMF044 | TMF039 | TMF034 | TMF029 |
|  | TMF045 | TMF040 | TMF035 | TMF030 |

 **NICKEL FREE!**







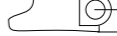

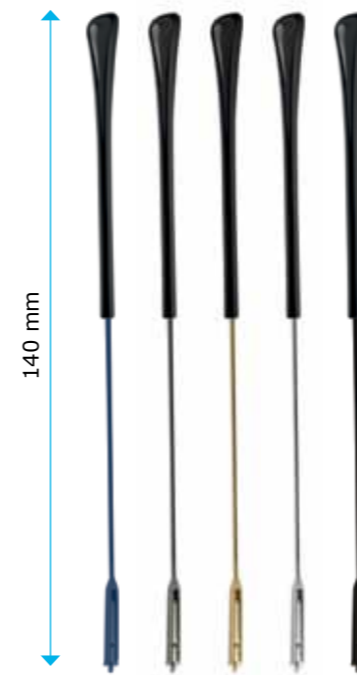
| | 2.2 mm | 2.2 mm | 2.8 mm | 3.0 mm |
|-------------------------------------------------------------------------------------|-------------------------------------------------------------------------------------|-------------------------------------------------------------------------------------|---------------------------------------------------------------------------------------|---------------------------------------------------------------------------------------|
|  |  |  |  |  |
| | 0.8 mm | 1.0 mm | 1.2 mm | 1.4 mm |
|  | TMF005 | TMF010 | TMF015 | TMF020 |
|  | TMF004 | TMF009 | TMF014 | TMF019 |
|  | TMF003 | TMF008 | TMF013 | TMF018 |
|  | TMF002 | TMF007 | TMF012 | TMF017 |
|  | TMF001 | TMF006 | TMF011 | TMF016 |

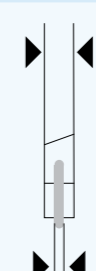
METAL FLEX TEMPLES

1 pair  $\phi 1.4$ mm  2.3 mm



| | 3 mm |
|-------------------------------------------------------------------------------------|-------------------------------------------------------------------------------------|
|  |  |
| | 0.9 mm |
|  | TMF021 |
|  | TMF022 |
|  | TMF023 |
|  | TMF024 |
|  | TMF025 |

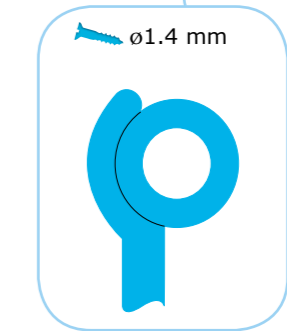



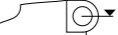

 **ANTI-ALLERGY!**





ACETATE FLEX TEMPLES

1 pair  $\phi 1.4$ mm  4.5 mm

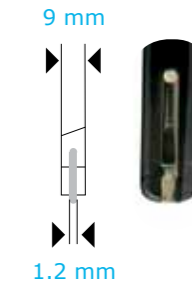



| | 140 mm |
|---------------------------------------------------------------------------------------|--------|
|  | TAF017 |
|  | TAF018 |
|  | TAF019 |
|  | TAF020 |



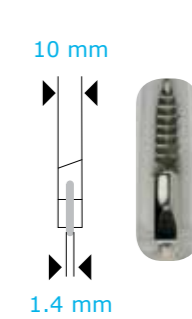

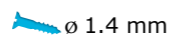

| | 140 mm |
|---------------------------------------------------------------------------------------|--------|
|  | TAF021 |
|  | TAF022 |
|  | TAF023 |
|  | TAF024 |







ACETATE FLEX TEMPLES

1 pair  $\varnothing 1.4 \text{ mm}$  4.5 mm

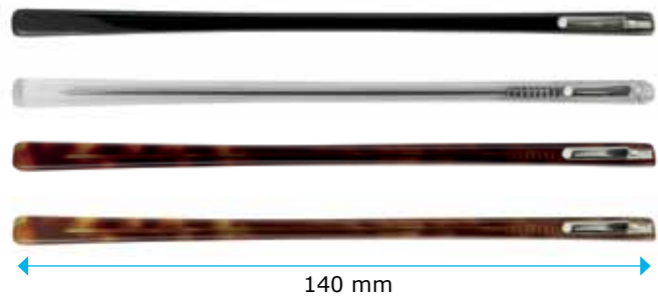
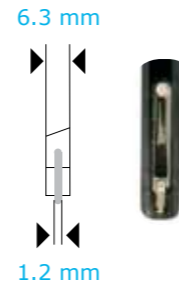





- 140 mm**
-  TAF013
 -  TAF014
 -  TAF015
 -  TAF016

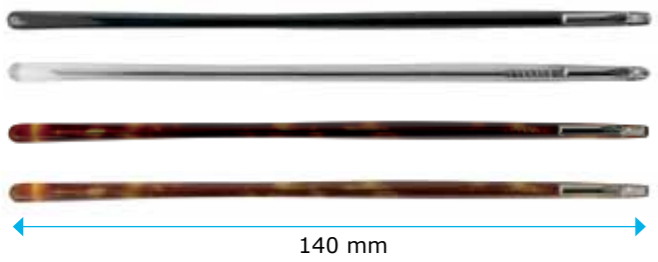
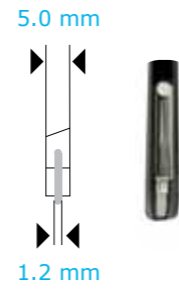





- 140mm**
-  TAF009
 -  TAF010
 -  TAF011
 -  TAF012

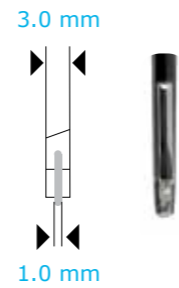

- 140mm**
-  TAF001
 -  TAF002
 -  TAF003
 -  TAF004



- 140mm**
-  TAF005
 -  TAF006
 -  TAF007
 -  TAF008

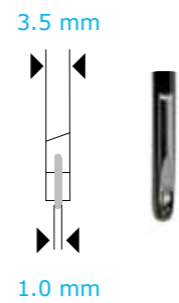











ACETATE TEMPLE ENDS

5 Pairs





CLASSIC STYLE



| | $\varnothing 1.2$ | $\varnothing 1.45$ | $\varnothing 1.6$ |
|-------------------------------------------------------------------------------------|-------------------|--------------------|-------------------|
| 65 mm | | | |
|  | TEDA01 | TEDA06 | - |
|  | TEDA02 | TEDA07 | - |
|  | TEDA03 | TEDA08 | - |
|  | TEDA04 | TEDA09 | - |
|  | TEDA05 | TEDA10 | - |
| 69.5 mm | | | |
|  | - | - | TEDA11 |
|  | - | - | TEDA12 |
|  | - | - | TEDA13 |
|  | - | - | TEDA14 |
|  | - | - | TEDA15 |





GOLF STYLE



| | $\varnothing 1.2$ | $\varnothing 1.45$ |
|---------------------------------------------------------------------------------------|-------------------|--------------------|
| 65 mm | | |
|  | TEDA16 | TEDA21 |
|  | TEDA17 | TEDA22 |
|  | TEDA18 | TEDA23 |
|  | TEDA19 | TEDA24 |
|  | TEDA20 | TEDA25 |

MODERN STYLE



| | $\varnothing 1.6$ |
|---------------------------------------------------------------------------------------|-------------------|
| 65 mm | |
|  | TEDA26 |
|  | TEDA27 |
|  | TEDA28 |
|  | TEDA29 |
|  | TEDA30 |

ACETATE TEMPLE ENDS

5 pairs

THIN STYLE



| | | |
|----------------|----------|--|
| | ø 0.9 mm | |
| 69.5 mm | | |
| | TEDA31 | |
| | TEDA32 | |
| | TEDA33 | |

LONG STYLE



| | | |
|---------------|-----------|-----------|
| | ø 1.45 mm | ø 1.20 mm |
| 135 mm | | |
| | TEDA34 | TEDA37 |
| | TEDA35 | TEDA38 |
| | TEDA36 | TEDA39 |

SILICONE NON SLIP TEMPLE ENDS

25 pairs



| | | | |
|--|--------|--------|--------|
| | TEDS01 | | |
| | TEDS02 | | |
| | TEDS03 | 5.9 mm | 2.7 mm |
| | TEDS04 | | |
| | TEDS05 | | |
| | TEDS06 | 2.8 mm | 1.8 mm |

SPECTACLE CORDS

100 Pcs- 70 cm

Black cord
COR001



Brown cord
COR002



SCREW ASSORTMENT

40 Pcs of each

An essential assortment of 1120 frames parts divided into 28 items
In sachet
Ref : SET002

HINGES

| | | | |
|----------------------------------------------|----------------------------------------------|-------------------------------------------------------|----------------------------------------------|
| SCR001 ◐ ø 1.2mm 3.2mm 1.6mm | SCR004 ◐ ø 1.3mm 7.0mm 1.8mm | SCR005 ◐ ø 1.4mm 3.9mm 1.8mm | SCR006 ◐ ø 1.4mm 3.9mm 1.8mm |
| SCR008 ◐ ø 1.4mm 5.2mm 1.8mm | SCR009 ◐ ø 1.4mm 5.2mm 1.8mm | SCR010 ◐ ø 1.4mm 6.5mm 1.8mm | SCR011 ◐ ø 1.4mm 4.3mm 2.0mm |
| SCR012 ◐ ø 1.4mm 4.3mm 2.0mm | SCR013 ◐ ø 1.5mm 5.2mm 1.8mm | SCA008 ◐ ø 1.4mm 2.0mm 6.5mm 3.5mm | |

RIMLESS FRAMES

| | |
|-----------------------------------------------|-----------------------------------------------|
| SCF001 ◐ ø 1.2mm 15.0mm 1.8mm | SCF002 ◐ ø 1.2mm 15.0mm 1.8mm |
| NRS001 ◐ ø 2.5mm 1.2mm | NRS002 ◐ ø 2.5mm 1.2mm |
| WAS001 ◐ ø 2.5mm 1.2mm | WAS002 ◐ ø 2.5mm 1.2mm |

NOSE PADS

| | |
|----------------------------------------------|----------------------------------------------|
| SCN002 ◐ ø 1.0mm 3.8mm 1.8mm | SCN004 ◐ ø 1.0mm 4.0mm 1.2mm |
| SCN005 ◐ ø 1.0mm 4.0mm 1.4mm | SCN010 ◐ ø 1.1mm 4.2mm 1.3mm |

TEMPLES

| | | | |
|-----------------------------------------------|----------------------------------------------|----------------------------------------------|----------------------------------------------|
| SCH002 ◐ ø 1.3mm 5.3mm 1.7mm | SCH003 ◐ ø 1.4mm 2.7mm 2.0mm | SCH007 ◐ ø 1.4mm 5.0mm 1.8mm | SCH009 ◐ ø 1.4mm 8.6mm 2.8mm |
| SCH010 ◐ ø 1.4mm 11.4mm 2.8mm | SCH014 ◐ ø 1.6mm 5.2mm 1.8mm | SCH016 ◐ ø 1.6mm 9.0mm 2.8mm | |

The Essentials

- The new range of kits composed of Opticians' favorite references.
- A practical box, easy to carry, with no risk to lose or mix up pieces.
- Any missing reference is immediately noticeable and could be ordered individually.
- The reference label makes easy to find a product in the box.



THE ESSENTIALS – NOSE PADS

20 Pairs of each

In push

SET011

| | | | | | |
|--------------------------------|--------------------------------|-------------------------|-------------------------|-------------------------|-------------------------|
| NPSS01 9mm | NPSS05 11mm | NPSS07 13mm | NPSS09 14.5mm | NPSS13 11mm | NPSS15 13mm |
| NPSS17 14.5mm | NPSM03 11mm | NPSM04 12.5mm | NPSM05 14.5mm | NPC001 13mm | NPC002 15mm |
| NPSB04 5 Pcs 32mm | NPSB06 5 Pcs 44mm | NPSS21 12.5mm | NPPS32 13mm | NPPS27 12.5mm | NPPS28 12.5mm |

THE ESSENTIALS – NOSE PADS

20 Pairs of each

In screw

SET012

| | | | | | |
|-------------------------|-------------------------------------|-------------------------|-------------------------|--------------------------------|--------------------------------|
| NPSS06 11mm | NPSS08 13mm | NPSS10 14.5mm | NPSS02 9mm | NPSS18 14.5mm | NPSS07 13mm |
| NPSS16 13mm | NPSD02 Left Right 13mm | NPC001 13mm | NPC002 15mm | NPSB04 5 Pcs 32mm | NPSB06 5 Pcs 44mm |
| NPSM04 12.5mm | NPSM01 11mm | NPPS30 12mm | NPPS28 12.5mm | NPSS22 12.5mm | NPSS14 11mm |

THE ESSENTIALS - DRILLING

 100 Pcs of each

SET013

| | | | | | |
|---------------------------------------|-----------------------------------------|---------------------------------------------------------|--------------------------------------------------|--------------------------------------------------|---------------------------------------|
| SLR001 • 2.8mm ∅ 1.2mm | SLR002 • 2.8mm ∅ 1.4mm | SLR003 open version medium soft ∅ 1.3mm | SLR004 soft ∅ 1.4mm | SLR005 open version soft ∅ 1.4mm | SLR007 hard ∅ 1.4mm |
| SLR008 hard ∅ 1.5mm | SLR009 medium soft ∅ 1.5mm | SLR010 soft ∅ 1.8mm | SLR011 open version hard ∅ 1.8mm | NRS001 ⚙ • 2.5mm ∅ 1.2mm | WAS001 ⚙ • 2.5mm ∅ 1.2mm |
| WAS005 ⚙ • 2.5mm ∅ 1.2mm | NRS005 ⚙ • 2.5mm ∅ 1.4mm | WAS006 ⚙ • 2.5mm ∅ 1.4mm | WAS010 ⚙ • 2.8mm ∅ 1.4mm | NRS002 ⚙ • 2.5mm ∅ 1.2mm | WAS002 ⚙ • 2.5mm ∅ 1.2mm |

THE ESSENTIALS - SCREWS

 100 Pcs of each

SET014

| | | | | | |
|--------------------------------------------------------|--------------------------------------------------------|--------------------------------------------------------|--------------------------------------------------------|--------------------------------------------------------|--------------------------------------------------------|
| SCR001 ⚙ ∅ 1.2mm • 3.2mm • 1.6mm | SCR005 ⚙ ∅ 1.4mm • 3.9mm • 1.8mm | SCR003 ⚙ ∅ 1.2mm • 4.7mm • 1.6mm | SCR011 ⚙ ∅ 1.4mm • 4.3mm • 2.0mm | SCA001 ⚙ ∅ 1.0mm • 1.4mm • 5.8mm 2.8mm | SCA003 ⚙ ∅ 1.2mm • 2.0mm • 5.9mm 3.5mm |
| SCN008 ⚙ ∅ 1.0mm • 4.0mm • 1.4mm | SCA006 ⚙ ∅ 1.3mm • 2.0mm • 6.5mm 3.5mm | SCA019 ⚙ ∅ 1.4mm • 2.0mm • 6.5mm 2.5mm | SCA008 ⚙ ∅ 1.4mm • 2.0mm • 6.5mm 3.5mm | SCF011 ⚙ ∅ 1.4mm • 12.0mm • 2.5mm | SCA011 ⚙ ∅ 1.4mm • 2.0mm • 7.0mm 4.0mm |
| SCA013 ⚙ ∅ 1.4mm • 2.0mm • 7.8mm 4.8mm | SCN001 ⚙ ∅ 0.8mm • 3.7mm • 1.0mm | SCN002 ⚙ ∅ 1.0mm • 3.8mm • 1.8mm | SCN004 ⚙ ∅ 1.0mm • 4.0mm • 1.2mm | SCN005 ⚙ ∅ 1.0mm • 4.0mm • 1.4mm | SCF001 ⚙ ∅ 1.2mm • 15.0mm • 1.8mm |

THE ESSENTIALS - TEMPLE TIPS









 20 Pairs of each

SET015

| | | |
|---------------------------------|--------------------------------|-------------------------------|
| TEDA08 65mm ∅ 1.45mm | TEDA28 65mm ∅ 1.6mm | TEDA03 65mm ∅ 1.2mm |
| TEDA23 65mm ∅ 1.45mm | TEDA26 65mm ∅ 1.6mm | TEDA29 65mm ∅ 1.6mm |
| TEDA13 69.5mm ∅ 1.6mm | TEDA10 65mm ∅ 1.45mm | |

THE ESSENTIALS - METAL FRAMES

SET016

| | | |
|-------------------------------------------------------------------------------------------------------------------------------------------|---------------------------------------------------------------------------------------------------------------------------------------------------------------------------------------------|-------------------------------------------------------------------------------------------------------------------------------------------------------------------------------------------|
| Metal Temples 1.3mm 0.95mm | | |
| TM0021 Silver  3 Pairs | TM0022 Gold  3 Pairs | TM0023 Black  3 Pairs |
| PAM006 15 Pairs Pad Arms for Metal Frames, Nickel Free, (Clip-On), Silver | NPPS33  50 Pcs PVC Transparent with Silver Coloured Metal Insert, Symmetrical, Clip On | NPPS34  50 Pcs PVC Transparent with Gold Coloured Metal Insert, Symmetrical, Clip On |
| PAM005 15 Pairs Pad Arms for Metal Frames, Nickel Free, (Clip-On), Gold | SCR014 Silver  50 Pcs 1.2mm 3.4mm 1.6mm | SCR015 Gold  50 Pcs 1.2mm 3.4mm 1.6mm |
| SCH017 Silver  50 Pcs 1.3mm 3.5mm 1.7mm | SCH018 Gold  50 Pcs 1.3mm 3.5mm 1.7mm | |



OPTOMETRY

| | |
|-------------------------------------|------|
| TRIAL CASES AND TRIAL FRAME | 4-2 |
| PROXIMETER - OPTOMETRIC ACCESSORIES | 4-4 |
| OCCCLUSION FOILS | 4-8 |
| PRISMS AND ASPHERICAL LENSES | 4-10 |





LARGE TRIAL CASE

Ref: ESS260

- 260 lenses, 22mm aperture.
- Spherical lenses: ± 0.25 to $\pm 20.00 \delta$.
- Cylindrical lenses: ± 0.25 to $\pm 6.00 \delta$.
- Prismatic lenses: 0.5 to 10 Δ .
- Accessories: cross, mobile crossed cylinders, slit, Maddox, plano lens, red/green filters, occlusion, stenopeic hole.
- Dimensions:
Tray on its own: L 440 x P 320 x H 45 mm.
Full box: L 470 x P 350x H 100 mm.
- Weight: 4.750 kg.



SMALL TRIAL CASE

Ref: ESS167

- 167 lenses, 22 mm aperture.
- Spherical lenses: ± 0.25 to $\pm 16.00 \delta$.
- Cylindrical lenses: ± 0.25 to $\pm 4.00 \delta$.
- Prismatic lenses: 1 to 5 Δ .
- Accessories: mobile crossed cylinders, slit, red/green filters, occlusion, stenopeic hole.
- Dimensions:
Tray on its own: L 440 x P 265 x H 45 mm.
Full box: L 465 x P 300x H 100 mm.
- Weight: 3.8 kg.



Ref : ESS 304

- PD: 46 to 82 mm.
- Adjustable temple length and angle.
- Vertex distance measurement scale.
- Space for 10 trial lenses.

OPTION

Ref : ESS 305

Slip-on polarizing filter with 2 settings (near/distance) available as an optional extra.



Ref : ESS 204

- PD: 48 to 80 mm.
- Adjustable temple length and angle.
- Vertex distance measurement scale.
- Space for 10 trial lenses.

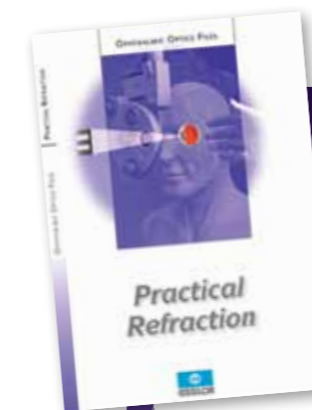

Ophthalmic Optics Files
Available in more than 10 languages.
Ref : COO

Essilor's collection of Ophthalmic Optics Files are thematically structured and well illustrated files containing many of the theoretical principles of optics and their applications and technics. From a definition of refractive index to lens geometry, from material composition and coatings to the description of progressive surfaces, these files will provide valuable information to support you in your profession.

PROXIMETER

Ref: Proxim

The Proximeter® is a simple instrument which can be used by all eyecare professionals. It allows a subjective analysis of various visual functions at a given near vision distance and with lowered gaze. It is an essential tool in daily practice, which can be used to ensure optimal visual performance of the prescription before fitting the client with single-vision, progressive or contact lenses. It can also be used to assess the remaining visual capacity of a patient with subnormal vision in order to evaluate the magnification required.



Proximeter is supplied with:

- 8 CHARTS:

- A reading chart with 100 % and 10 % contrast.
- Letter acuity chart with 100 % and 10 % contrast.
- Letter chart and Snellen's chart for low vision acuity testing.
- Red-green test, Helmholtz target Cross test and Bird-shot test.
- Excentric fixation test.
- Horizontal lines of letters and vertical lines of letters.
- Four-dots Worth and Cross test.
- Brock's rings test.

- 3 SETS OF 4 DUAL LENS-HOLDERS:

- -1.00, -0.75, -0.50, -0.25 (lens-holders for people without presbyopia).
- +0.25, +0.50, +0.75, +1.00 (lens-holders for people with recent onset of presbyopia).
- +1.25, +1.50, +1.75, +2.00 (lens-holders for people with confirmed presbyopia).



ESSILOR STEREO TEST

With polarised glasses and results reading table.

Ref: MAG200

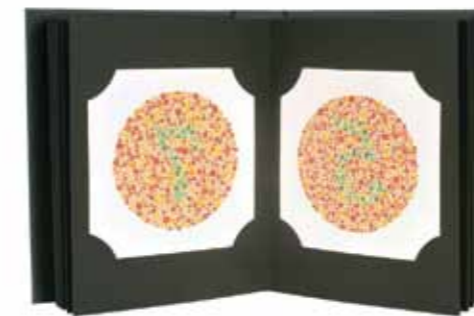

ISHIHARA TEST

ISHIHARA - 14 Plates Ref: MAG301
 ISHIHARA - 24 Plates Ref: MAG302
 ISHIHARA - 38 Plates Ref: MAG303



BINOCULAR CONFIRMATION TEST

With protection case.

SPH +/- 0.25 δ Ref: MAG180
 SPH +/- 0.50 δ Ref: MAG181



CROSS CYLINDER

Set of 2 crossed cylinders of +/- 0.25 δ and +/- 0.5 δ.
 With protection case.

Ref: MAG175



PENLIGHT

Batteries not included Ref: MAG110



Mirror

Parinaud hand-help chart:
one side mirror, one side chart
Ref: ECH 201

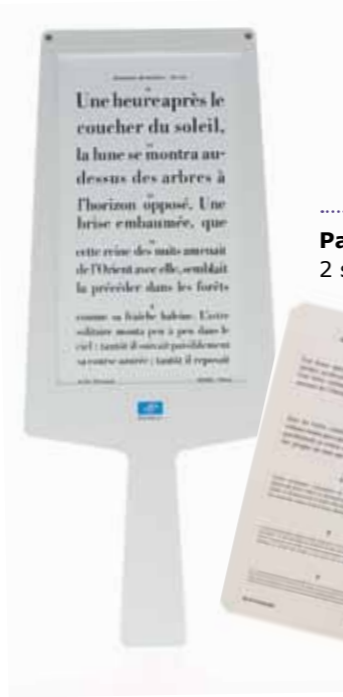

Parinaud hand-help chart:
2 sides text.
Ref: ECH 204



Reading chart for hand help :
Text scale from 2 to 6. Ref: ECH 203
Text scale from 8 to 16. Ref: ECH 205



Polarised filter. Ref: MAG 075
Red Maddox filter. Ref: MAG 077
Red/green filter Ref: MAG 076



White Occluder Ref: MAG 178
Red Occluder Ref: MAG 177

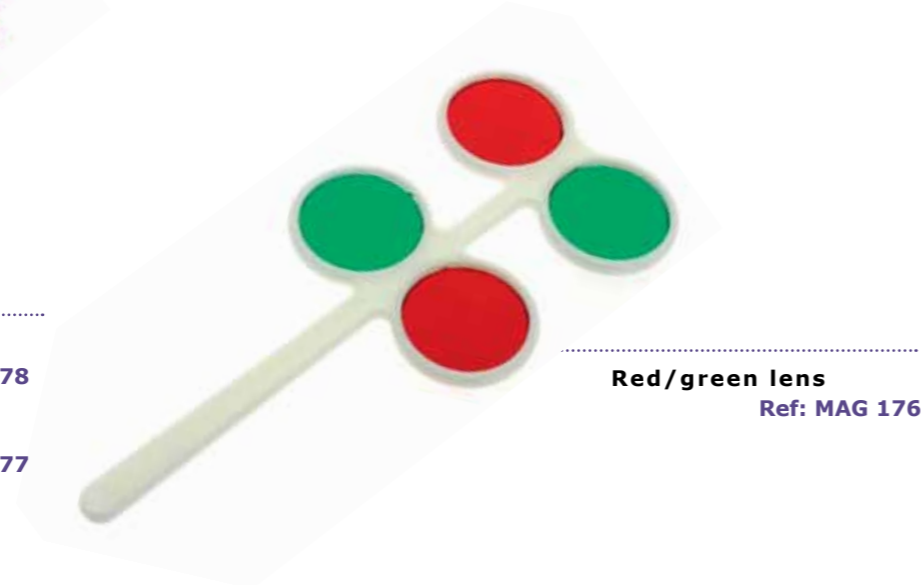

Red/green lens
Ref: MAG 176



Monoyer scale - Direct reading
reading distance 5 meters.
Ref: ECH101



Monoyer scale - Reverse reading
reading distance 2.5 meters.
Ref: ECH 102



Rational scale
reading distance 5 meters.
Ref: ECH 103

A UNIQUE TOOL TO MEASURE VISUAL ACUITY



IN FAR VISION



IN NEAR VISION



Galinet scale
Réf: ECH300

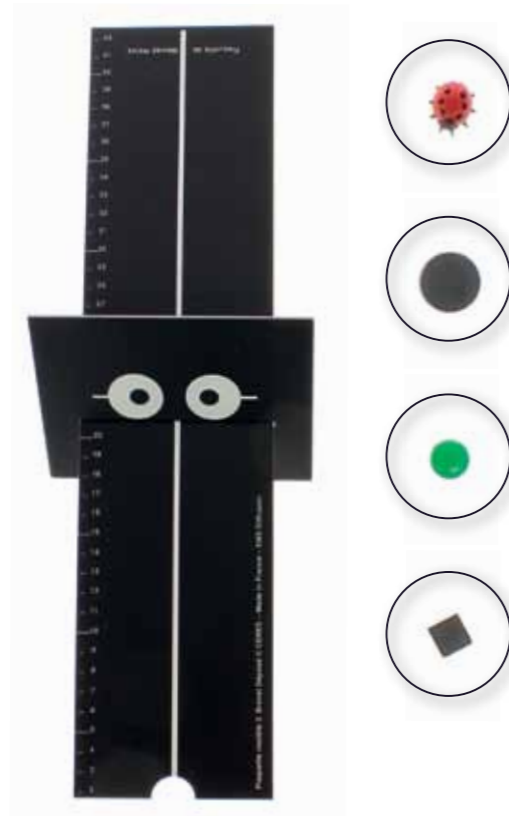

MAWAS RULER

- Delivered with:**
- one ruler
 - one grade ruler
 - four magnets

Ref: **MAG081**



OPTICLUDE™

| | | | |
|--------|------------|-----------|--------------------|
| Adult | 80 x 57 mm | Box of 20 | Ref: OPTI01 |
| Junior | 60 x 50 mm | Box of 20 | Ref: OPTI02 |

RYSER – OCCUSION FOILS

Packing: per unit or pack of 4.



| Visual acuity | Number | Ref pack of 4 | Ref. per unit |
|-----------------|--------|---------------|---------------|
| 10/10 | 1 | MAG001 | RYS001 |
| 8/10 | 2 | MAG002 | RYS002 |
| 6/10 | 3 | MAG003 | RYS003 |
| 4/10 | 4 | MAG004 | RYS004 |
| 3/10 | 5 | MAG005 | RYS005 |
| 2/10 | 9 | MAG009 | RYS009 |
| +1/10 | 6 | MAG006 | RYS006 |
| 1/10 | 7 | MAG007 | RYS007 |
| Total occlusion | | MAG008 | RYS008 |

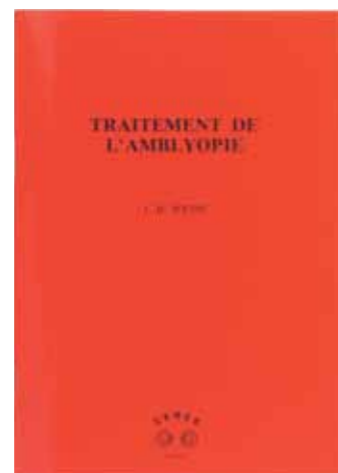
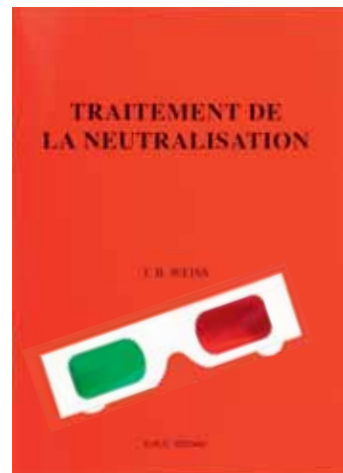

EXERCISE BOOKS

| | | | |
|--------------------------|------------------------|-----------------|--------------------|
| Amblyopia exercises | Black letters | E and labyrinth | Ref: MAG082 |
| Neutralisation exercises | Red letters | E and labyrinth | Ref: MAG083 |
| Fusion exercises | Red letters with black | E and labyrinth | Ref: MAG084 |

PRISM FOILS

Useful Diameter: 67 mm
Packing: per unit or pack of 2.



| Effect dpt. | Ref. per unit | Ref. pack of 2 | Effect dpt. | Ref. per unit | Ref. pack of 2 |
|-------------|---------------|----------------|-------------|---------------|----------------|
| 1 | PS0010 | MAG020 | 10 | PS0100 | MAG029 |
| 2 | PS0020 | MAG021 | 12 | PS0120 | MAG030 |
| 3 | PS0030 | MAG022 | 15 | PS0150 | MAG031 |
| 4 | PS0040 | MAG023 | 20 | PS0200 | MAG032 |
| 5 | PS0050 | MAG024 | 25 | PS0250 | MAG033 |
| 6 | PS0060 | MAG025 | 30 | PS0300 | MAG034 |
| 7 | PS0070 | MAG026 | 35 | PS0350 | MAG035 |
| 8 | PS0080 | MAG027 | 40 | PS0400 | MAG040 |
| 9 | PS0090 | MAG028 | | | |

SCALED PRISMS

Size: 55 x 55 mm.
Pack of 2.



| Effect dpt. | Ref. | Effect dpt. | Ref. |
|-------------|--------|-------------|--------|
| 10 | MAG065 | 22.5 | MAG070 |
| 12.5 | MAG066 | 25 | MAG071 |
| 15 | MAG067 | 27.5 | MAG072 |
| 17.5 | MAG068 | 30 | MAG073 |
| 20 | MAG069 | 35 | MAG074 |

SOFT ASPHERICAL LENSES



PLUS LENSES

| Ref. | Effect dpt. |
|--------|-------------|
| +0.50 | AP0050 |
| +1.00 | AP0100 |
| +1.50 | AP0150 |
| +2.00 | AP0200 |
| +2.50 | AP0250 |
| +3.00 | AP0300 |
| +3.50 | AP0350 |
| +4.00 | AP0400 |
| +5.00 | AP0500 |
| +6.00 | AP0600 |
| +7.00 | AP0700 |
| +8.00 | AP0800 |
| +10.00 | AP1000 |
| +12.00 | AP1200 |
| +14.00 | AP1400 |
| +16.00 | AP1600 |



MINUS LENSES

| Ref. | Effect dpt. |
|---------|-------------|
| - 1.00 | AN0100 |
| - 2.00 | AN0200 |
| - 3.00 | AN0300 |
| - 4.00 | AN0400 |
| - 5.00 | AN0500 |
| - 6.00 | AN0600 |
| - 7.00 | AN0700 |
| - 8.00 | AN0800 |
| - 9.00 | AN0900 |
| - 10.00 | AN1000 |
| - 11.00 | AN1100 |
| - 12.00 | AN1200 |
| - 13.00 | AN1300 |
| - 14.00 | AN1400 |





WORKING AIDS

| | |
|-------------------|-----|
| JOB TRAYS | 5-2 |
| STORAGE BOXES | 5-4 |
| LIQUID CONTAINERS | 5-5 |
| TOOL STANDS | 5-6 |



| Set of 10 job trays | Large | Small |
|---------------------|--------|--------|
| | PEN032 | PEN022 |
| | PEN034 | PEN024 |
| | PEN031 | PEN021 |
| | PEN035 | PEN025 |
| | PEN030 | PEN020 |
| | PEN033 | PEN023 |
| | PEN036 | PEN026 |

JOB TRAYS "POP" 10 Pcs

Available in 2 sizes and 7 colors.

- With label pockets.
- Material: Soft Plastic.
- Small:
Total size : L 170 X W 244 X H 45 mm
Inner size : L 149 X W 225 X H 40 mm
- Large:
Total size: L 190 X W 270 X H 50 mm
Inner size: L 159 X W 242 X H 44 mm



JOB TRAYS

Available in 4 colors.

- Slot for cupboard label.
- Material: Soft plastic.
- Total size: L 168 X W 240 X H 52 mm
- Inner size: L 159 X W 229 X H 41 mm

| Set of 10 | Ref: |
|-----------|--------|
| Purple | PENP01 |
| Orange | PENP02 |
| Blue | PENP03 |
| Cristal | PENP04 |



PVC JOB TRAYS

Available in 2 colors.

- Material: PVC.
- Size: L 165 X W 260 X H 45 mm

| Set of 10 | Ref: |
|-----------|--------|
| Red | PEN004 |
| Cristal | PEN003 |

ACCESSORIES

- Set of 10 adhesive labels 70 mm PEN050
- Set of 10 cardboard labels 70 x 25 mm PENE01
- Set of 10 erasable labels 70 x 25 mm PEN005



WORKING AIDS



Metal stand for job trays

With handle. Metal storage for 10 jobs trays.
Size: 570 x 170 x 250 mm.

Ref: PEN 100



Pads distributor

Makes easier pads handling.

Ref: BOI004

STORAGE BOXES



Frame parts storage

Drawer heights: 26 mm
Removable compartments
Size: L 275 x P 260 x H 160 mm.

A box

Ref: BOI001



Screw storage box

Sliding cover - 11 compartments.

A box

Ref: BOI012



Storage box

Storage of 10 drill bits or mills.

A box

Ref: BOI003



Screw storage box

12 compartments.
Size: L 190 x P 110 x H 35 mm.

A box

Ref: BOI002



LIQUID CONTAINERS



SIMPLE DOSAGE SYSTEM BY LIGHT PRESSURE ON THE TIP.



Stick'Clean

Glass mark eraser - refillable

1 pcs (empty)

Ref: SNE100

set of 10 replacement tips

Ref: SNE110



Grade glass beaker

Capacity: 1000 ml

Ref: COL300



PVC bottle

with screwed cap.
Size : 250 ml.

A bottle

Ref: MUS004

Caps

1) Straight jet

Ref: MUS011

2) Spray

Ref: MUS013

3) Sprayer

Ref: MUS012

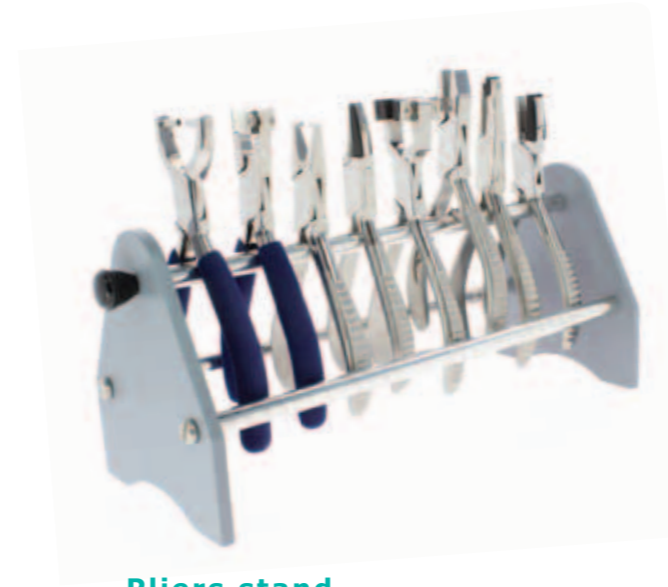

Pliers stand

Length: 250 mm

Contents not included

Ref: GAM039

TOOL STANDS



Pliers and screwdrivers stand

Length: 210 mm

Contents not included

Ref: RAT002



Magnetic tool bar

Length: 260 mm

Contents not included

Ref: RAT001





CONSUMABLES

| | |
|--------------------------------------------------------|------|
| CLEANING | 6-2 |
| GLUE - TINTS | 6-4 |
| MARKING - NYLOR FRAMES | 6-6 |
| POLISHING - SOLDERING - ROUGHINGS | 6-8 |
| PADS AND BLOCKS | 6-10 |
| EDGING, CHAMFERING, GROOVING WHEELS | 6-12 |
| BULBS | 6-16 |
| CONSUMABLES AND ACCESSORIES FOR INSTRUMENTS | |
| EDGERS - TRACERS | 6-18 |
| OTHER WORKSHOP EQUIPMENT | 6-26 |
| FITTING TOOLS - LENS DEMONSTRATORS | 6-30 |
| LENSMETERS | 6-32 |
| REFRACTION INSTRUMENTS | 6-34 |

CLEANING



Essiclean

Lens ink remover solution

1 bottle - 1 L

Ref: SNE801

12 bottles

Ref: SNE812



SIMPLE DOSAGE SYSTEM
BY LIGHT PRESSURE ON
THE TIP.



Stick'Clean

Lens ink remover - refillable

1 pcs (empty)

Ref: SNE100

set of 10 tips

Ref: SNE110



**Cleaning solution
for ultrasonic device**

For all kind of lens material - To be diluted.

1 bottle

1 litre

Ref: MUS001



Paper towels

Pack of 56 pcs

1 pack

Ref: PAP001

18 pack

Ref: PAP018

Microfibre tissues

Blue tissues - 32 x 36 cm

Pack of 5

Ref: NET011

White tissues - 16 x 16 cm

Pack of 50

Ref: NET010



Pressurized duster

Air Spray

650 ml

Ref: MUS003



ANTISTATIC

Cleaning foam

Aerosol spray

400 ml

Ref: NET001



GLUE AND SILICONE



Loctite thread sealant

10 ml size Ref: COL003
50 ml size Ref: CX4174



PC glue

20 g size Ref: CX4213



Glue gel for sloping surface

Polymerization in 30 sec. 5 g Tube Ref: COL002



Fluide glue for precision work

Polymerization in 5 sec. 3 g Tube Ref: COL001



Liquide Silicone with a lot of fluidity - Application with a needle tip

9 ml tube Ref: SIC001



Grade glass beaker

Capacity : 1000 ml Ref: COL300



Transfer liquid

Ensures uniform distribution of temperature in the dye tank

5 L Can Ref: COL202



Bleaching agent

For tinting organic lens

1 L bottle Ref: COL200

Pre coloring cleaner

Removes all marks, ensures a perfect pigment distribution

1 L bottle Ref: COL201

TINTS



Tints with stabilizer (pack of 3)

- COL008 Beige
- COL016 Pink brown
- COL017 Chestnut brown
- COL018 Brown Essilor
- COL024 Green gray
- COL028 Gray Essilor
- COL029 Ashes gray
- COL036 Pistachio Essilor
- COL037 Green plant
- COL038 Green Essilor
- COL040 Ultramarine
- COL044 Dark blue
- COL046 Periwinkle Blue
- COL050 Yellow Gold
- COL060 Gooseberry
- COL062 Ruby
- COL064 Pink Essilor
- COL072 Orange
- COL082 Purple
- COL092 Mauve
- COL100 Black



MARKING PENS



Marker

Bullet tip 1 mm, opaque ink

| | | |
|-------------------|-----------|---------------------|
| White | per unit | Réf : CRA002 |
| | pack of 5 | Réf : GAM205 |
| Black | | Réf : CRA010 |
| Red | | Réf : CRA011 |
| Yellow | | Réf : CRA012 |
| Dark green | | Réf : CRA013 |
| Dark blue | | Réf : CRA014 |
| Light blue | | Réf : CRA015 |
| Pink | | Réf : CRA016 |
| Pack of 8 markers | | Réf : CRA018 |

Large tip marker

| | | |
|----------|-----------|--------------------|
| Blue ink | Pack of 5 | Ref: GAM204 |
|----------|-----------|--------------------|

Permanent marker

| | | |
|------------------|---------|--------------------|
| Thin tip 0.05 mm | 1 Piece | Ref: CRA003 |
| Black ink | | |

Permanent marker

| | | |
|-----------------|---------|--------------------|
| Thin tip 0.4 mm | 1 Piece | Ref: CRA005 |
| Black ink | | |

3mm mine holder

| | | |
|------------------------|--|--------------------|
| Mine holder | | Ref: CRA001 |
| Pack of 12 white mines | | Ref: CRA004 |



Tracer tip type KITTRASS

| | | |
|------------------|------------|--------------------|
| Hodler + 2 tips | 1 Piece | Ref: POI003 |
| Blade o Kittrass | Pack of 10 | Ref: POI004 |

Tracer tip

| | | |
|------------------|---------|--------------------|
| Tungsten carbide | 1 Piece | Ref: POI001 |
|------------------|---------|--------------------|



Nylon thread hook

| | | |
|------------------|-----------|--------------------|
| Handle and hook | 1 Piece | Ref: OFN001 |
| Replacement hook | Pack of 3 | Ref: OFN010 |

8 SHAPE

10M/roll

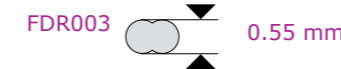

ROUND

20M/roll

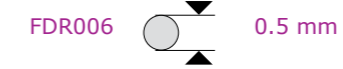

T SHAPE

5M/roll

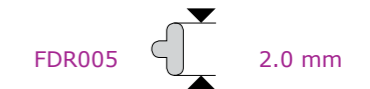
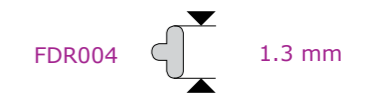

A COMPLETE SET OF NYLON THREADS TO CATER ALL YOUR NEEDS.

Ref: FDR101



| | | |
|----------|---------|--------|
| 10M/roll | 0.55 mm | FDR003 |
| 5M/roll | 1.3 mm | FDR004 |
| 5M/roll | 2.0 mm | FDR005 |
| 20M/roll | 0.5 mm | FDR006 |
| 20M/roll | 0.6 mm | FDR007 |



FELT WHEELS



Ø 100 mm Ø 100 mm Ø 100 mm Ø 100 mm

Cotton
Ref: TOU924 **Dark blue cloth**
Ref: TOU925 **Hard felt wheel**
Ref: TOU929 **Flannel**
Ref: TPC300

Ø 90 mm Ø 95 mm Ø 102 mm

Flannel
Ref: TOU930 **Circular cotton yarn brush**
Ref: TOU931 **Hard felt wheel**
Ref: TOU932

POLISHING PASTES

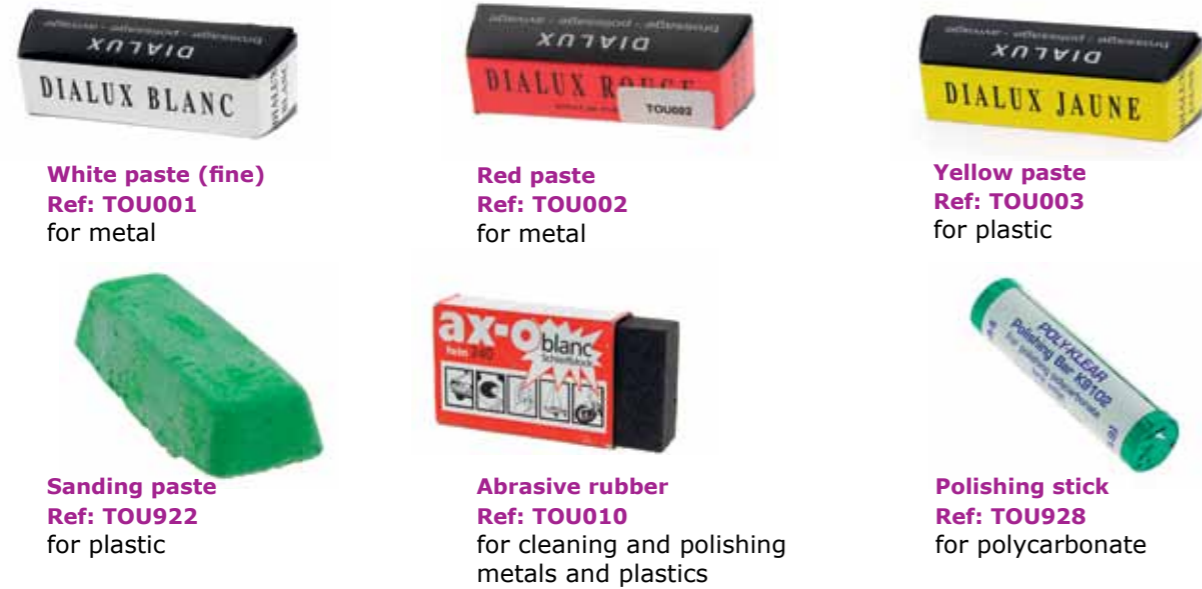

White paste (fine)
Ref: TOU001
for metal

Red paste
Ref: TOU002
for metal

Yellow paste
Ref: TOU003
for plastic

Sanding paste
Ref: TOU922
for plastic

Abrasive rubber
Ref: TOU010
for cleaning and polishing
metals and plastics

Polishing stick
Ref: TOU928
for polycarbonate

| USE | FELT WHEEL | PASTES |
|-------------------------|---------------|--------|
| Plastic burnishing | TOU924/TOU931 | TOU003 |
| Metal burnishing | TOU924/TOU931 | TOU002 |
| Gold burnishing | TPC300/TOU930 | TOU002 |
| Plastic smooth grinding | TOU925 | TOU922 |
| Metal smooth grinding | TOU925 | TOU922 |
| Organic glazing | TOU925 | TOU003 |
| PC glazing | TOU929/TOU932 | TOU928 |

SOLDERING



Gold solder
Ref: GAM053
Pack of 2 rolls
Ø 0.3 mm x 1.5 mm



Silver solder wire Ø 0.5 mm x 2.0 m
Ref: GAM054
1 roll
Wire length : 2 meters
Melting point : 650°C



Yellow solder sticks
Ref: SOU040
with fluid - Pack of 12

White solder sticks
Ref: SOU041
With fluid - Pack of 12

ROUGHINGS ET PATTERNS

Round patterns

Ø 78 mm Pack of 100 Ref: GAM076
Pack of 200 Ref: GAM077



Roughings

Roughings 5/10e - 600 x 70 mm Pack of 10 Ref: GAM056



MR BLUE - MR ORANGE
TRIPLETS



Blocks

| | | |
|------------|------------|--------------------|
| Ø 22 mm | Pack of 20 | Ref: GAM222 |
| Ø 18/14 mm | Pack of 20 | Ref: GAM218 |

Pads

| | | |
|------------|-----------------------------|------------------------------------------|
| Ø 22 mm | Roll of 1000 Roll of 200 | Ref: GAM403 Ref: GAM404 |
| Ø 18/14 mm | Roll of 1000 Roll of 200 | Ref: GAM316 Ref: GAM317 |

LENS PROTECTION
PADS



«Bluechip»

| | | |
|---------|--------------|--------------------|
| Ø 35 mm | Roll of 2000 | Ref: GAM207 |
|---------|--------------|--------------------|

KAPPA-GAMMA - ULTIMATE EDITION
DELTA-DELTA T



Blocks

| | | |
|------------|------------|--------------------|
| Ø 25 mm | Pack of 20 | Ref: GAM202 |
| Ø 18 mm | Pack of 10 | Ref: GAM203 |
| Ø 18/14 mm | Pack of 10 | Ref: GAM216 |

Pads

| | | |
|------------|-----------------------------|------------------------------------------|
| Ø 24 mm | Roll of 1000 Roll of 200 | Ref: GAM200 Ref: CY3108 |
| Ø 18 mm | Roll of 1000 Roll of 200 | Ref: GAM306 Ref: GAM301 |
| Ø 18/14 mm | Roll of 1000 Roll of 200 | Ref: GAM316 Ref: GAM317 |

PROFIL
RANGE



Blocks

| | | |
|---------|------------|--------------------|
| Ø 20 mm | Pack of 50 | Ref: GAM072 |
|---------|------------|--------------------|

SUCTION
CUPS



Suction cups

| | | |
|---------|-----------|--------------------|
| Ø 20 mm | Pack of 5 | Ref: GAM052 |
|---------|-----------|--------------------|

WHEELS



| | | | MR BLUE | | MR ORANGE | | KAPPA/GAMMA/DELTA ULTIMATE/TRIPLETS | |
|------------------|--------------|---------------------|---------|------------|-----------|------------|----------------------------------------|------------|
| | Material | Length | Wheel | Sharpering | Wheel | Sharpering | Wheel | Sharpering |
| Roughing | Mineral | 15 mm | CX3006 | CX5026 | CX3006 | CX5026 | CX3006 | CX5026 |
| | Plastic | 15 mm | CX3026 | | CX3026 | | CX3026 | |
| | | 15 mm rounded edges | CX3070 | | CX3070 | | CX3070 | |
| | | 22 mm | CX3025 | | CX3025 | | CX3025 | |
| | | 22 mm rounded edges | CX3069 | | CX3069 | | CX3069 | |
| Finishing | All Material | 19 mm | CX3021 | CX5051 | CX3021 | CX5051 | | |
| | | 22 mm | | | | | CX3020 | CX5024 |
| Polishing | Plastic | 15 mm | CX3060 | CX5054 | CX3060 | CX5054 | CX3060/ CX3028 | CX5054 |
| | | 22 mm | | | | | CX3061 | |



| | | | | | | | |
|-------------------|--------------|--|----------|--|--------|--|--------|
| Chamfering | Plastic | | CX3822 S | | CX3823 | | CX3815 |
| | All Material | | CX3826 | | CX3827 | | CX3818 |
| Grooving | Plastic | | CX3820 | | CX3824 | | CX3812 |
| High curve | Plastic | | CX3821 | | CX3825 | | |

We recommend you to check the wheel reference before ordering



PROFIL

| | Material | Length | Wheel |
|-----------|---------------|--------|---------------------|
| Roughing | Plastic | 15 mm | CX3007 |
| | | 22 mm | CX3010 |
| Finishing | All materials | 16 mm | CX3008 |
| | | 21 mm | CX3011* |
| | | 20 mm | CX3009** CX3015* |

* Free bevel
** Guided bevel

MMW

| | Material | Length | Wheel |
|-----------|-----------------|--------|--------|
| Roughing | Mineral Plastic | 25 mm | MMW901 |
| Finishing | Mineral Plastic | 25 mm | MMW902 |
| Polishing | Plastic | 25 mm | MMW903 |

MD2

| | Material | Length | Wheel |
|-------------------|-----------------|--------|--------|
| Roughing | Mineral Plastic | Plate | CX3003 |
| Finishing | Mineral Plastic | Plate | CX3004 |
| | | Cone | 1MSS01 |
| Bevel retouching | | Cone | 1MSS02 |
| Finition Corindon | | Cone | N21S05 |
| Grooving | All material | | CX3002 |

DIAFINE

| | Ref: |
|---------------------|--------|
| Polycarbonate | CX3030 |
| Mineral and Organic | CX3031 |

GROOVING

| ALL MATERIAL | Ref: |
|--------------|--------|
| MRT | MRT970 |
| RAYNIL | CX3005 |



SLIT LAMPS

■ **SLE 60**
Fixation point
Ref: SLE616



■ **SLE 70**
Fixation point
Ref: SLE722



■ **SLE 60**
Main lamp
Ref: SLE606



■ **SLE 70**
Main lamp
Ref: SLE721



■ **CPE 60**
30W
Ref: CPE618



■ **CPE 60**
Ref: CPE609



■ **CPE 50**
Ref: CPE101



■ **X75**
Pack of 2
Ref: GAM079



■ **Axil**
Pack of 2
Ref: GAM085



CHART PROJECTORS

LENSMETERS

OTHER PRODUCTS

EDGERS

■ **DPE 60**
Ref: DPE611



■ **PAL ID**
Ref: CA5050



■ **Tensiscope**
Pack of 2
Ref: GAM099



■ **Miroir VP**
Ref: CA5005



■ **Optoprox**
Ref: CA5023



■ **Eye chart display ELU080**
Ref: ELU822



■ **Eye chart display ELU090**
Ref: ELU815



■ **Edgers Kappa/Gamma**
Auger bulb
Ref: CA5072



■ **Hand Edgers MD2**
Pack of 4
Ref: GAM095



MR BLUE - MR ORANGE

CONNECTORS

| | | | |
|----------------------------------------|---------------|-----------------------|---------------|
| ■ Power cord (EU) | CA6320 | ■ Fuse 4 A Tempo 5x20 | CA1035 |
| ■ Power cord (US) | N66R43 | ■ Buld cover | N8216D |
| ■ Crossed Ethernet cable | CA6322 | ■ Auget LED board | M24R06 |
| ■ Network straight Ethernet cable (5m) | CD9231 | | |

BAR CODES

| | | | |
|---------------------------------------------------|---------------|----------------------------------|---------------|
| ■ Complete bar code option (for tracer and edger) | L14A00 | ■ Set of labels from 401 to 600 | X95A04 |
| ■ Bar code reader | DOUA24 | ■ Set of labels from 601 to 800 | X95A05 |
| ■ Set of labels from 001 to 200 | X95A02 | ■ Set of labels from 801 to 1000 | X95A06 |
| ■ Set of labels from 201 to 400 | X95A03 | | |

ACCESSORIES

| | | | |
|------------------------|----------------|--------------------------------------|----------------|
| ■ Touch screen pen | L1108P | Mr Blue specifics accessories | |
| ■ Calibration Tool | L11S44 | ■ Waste drawer subassy | M24S07 |
| ■ Deblocker plier | N82A03 | ■ RFP module accessories kit | M24A41 |
| ■ Spanner drilling | M24A410 | Drilling Fitting key | M24A410 |
| ■ Bent M Key TORX T10 | CX1025 | Grooving small wheel key | M24A411 |
| ■ Water feeding hose | CS3017 | Flat key 5 x 7,8 RFP | M24A412 |
| ■ Recovery bag | CS3027 | Bent M Key TORX T10 | CX1025 |
| ■ Dust cover Mr Orange | | ■ Dust cover Mr Blue | |
| Edger | M22A32 | Edger | M24A32 |
| Tracer/centrer/blocker | L1490A | Tracer/centrer/blocker | L1490A |

M' EYE SIGN

| | | | |
|--------------------------------------------------|---------------|---------------------------------------|---------------|
| ■ Curved block drilling key V3 | M24A76 | ■ Pin mandrin key V3 | M24A78 |
| ■ M'eye Sign booklet with glasses | MES113 | ■ 4 Shelf bakers | MES119 |
| ■ Kit of precut shapes | MET103 | ■ Kit of 25 M'eye touch pattern cards | MET104 |
| ■ Pack of 8 marking pens (Complete range, p 6-6) | CRA018 | | |



MR BLUE 2.0 MR BLUE MR ORANGE

SPINDLE MODULE

| | | | |
|---------------------------|----------------|----------------|----------------|
| Drilling mill ø 0,8 mm | FRA308 | FRA211 | FRA211 |
| Drilling mill ø 1 mm | FRA310 | FRA210 | FRA210 |
| Drilling spindle | M24S760 | M24S720 | M24S720 |
| Chamfering spindle | M24S730 | M24S730 | M22S430 |
| Roughing mill ø 1.2 mm | FRA212 | FRA212 | |
| Grooving/ milling spindle | M24S740 | M24S740 | |
| Engraving tool | M24S280 | | |



| | | | |
|----------------------------------------|------------------------------|------------------------------|--------------------------|
| | Ø 22 mm | Ø 18/14 mm | Weco Blocks 19/17 |
| Blocks | GAM222 (Pack of 20) | GAM218 (Pack of 20) | |
| Pads | GAM403 (Roll of 1000) | GAM316 (Roll of 1000) | |
| Block holder (Left side) | M24A16 | M24A15 | M24A17 |
| Clip-on plate subassembly (Right side) | M24A12 | M10A17 | M24A19 |
| Flexible stop | M24A33 (Pack of 10) | M1017A | |

CONNECTORS

| | | | |
|--------------------------|---------------|------------------------|---------------|
| ■ Power cord (EU) | CA6320 | ■ Fuse 2 A Tempo, 5x20 | CA1015 |
| ■ Power cord (US) | N66R43 | ■ Fuse 4 A Tempo 5x20 | CA1035 |
| ■ Crossed Ethernet cable | X83A01 | ■ Buld cover | N8216D |
| ■ Auget LED board | CA5072 | | |

BAR CODES

| | | | |
|---------------------------------------------------|---------------|--------------------------------------------|---------------|
| ■ Complete bar code option (for tracer and edger) | L14A00 | ■ Set of labels from 401 to 600 | X95A04 |
| ■ Bar code reader | DOUA24 | ■ Set of labels from 601 to 800 | X95A05 |
| ■ Set of labels from 001 to 200 | X95A02 | ■ Set of labels from 801 to 1000 | X95A06 |
| ■ Set of labels from 201 to 400 | X95A03 | ■ Labels D001 to D200 (Drilling bar codes) | L07A02 |

ACCESSORIES

| | | | |
|-----------------------------|---------------|-----------------------|---------------|
| ■ Edger adjusting gauge | N82A11 | ■ Recovery bag | CS3027 |
| ■ Orma plano lens | X83A15 | ■ Water collector | M0510A |
| ■ Deblocker plier | N82A03 | ■ Hexagonal key 2,5mm | CX1007 |
| ■ Calibration tool + button | X88A09 | ■ Hexagonal key 3mm | CX1005 |
| ■ Dust cover tracer | X8890A | ■ Flat key 5,5 / 7 mm | CX1023 |
| ■ Dust cover Edger | N8291A | ■ Bent M Key TORX T10 | CX1025 |
| ■ Water feeding hose | CS3017 | | |

SPINDLE MODULE

| | |
|---------------------|---------------|
| ■ Drill bit ø 0,8mm | M1553A |
| ■ Drill bit ø 1mm | M1554A |



KAPPA - GAMMA - ULTIMATE EDITION SERIES



| | | | | |
|------------------------------------|--------------------------|------------------------------|------------------------------|------------------------------|
| | | Ø 25 mm | Ø 18 mm | Ø 18/14 mm |
| | Blocks | GAM202 (Pack of 20) | GAM203 (Pack of 10) | GAM216 (Pack of 10) |
| | Pads | GAM200 (Roll of 1000) | GAM306 (Roll of 1000) | GAM316 (Roll of 1000) |
| | Block holder (Left side) | M1590C | M1590L | M1590D |
| Clip-on plate subassy (Right side) | Complete set | M10A08 | | |
| | Plate with flexible stop | M10A09 | M10A10 | M10A17 |
| | Flexible stop | N9581D | N9582B | M1017A |



NEKSIA

CONNECTORS

| | | | |
|-------------------------------|---------------|-----------------------|---------------|
| ■ Power cord (EU) | CA6320 | ■ Fuse 4 A Tempo 5x20 | CA1035 |
| ■ Power cord (US) | N66R43 | ■ Buld cover | N8216D |
| ■ Crossed Ethernet cable (5m) | CA6322 | | |

BAR CODES

| | | | |
|---------------------------------------------------|---------------|----------------------------------|---------------|
| ■ Complete bar code option (for tracer and edger) | L14A00 | ■ Set of labels from 401 to 600 | X95A04 |
| ■ Bar code reader | DOUA24 | ■ Set of labels from 601 to 800 | X95A05 |
| ■ Set of labels from 001 to 200 | X95A02 | ■ Set of labels from 801 to 1000 | X95A06 |
| ■ Set of labels from 201 to 400 | X95A03 | | |

ACCESSORIES

| | | | |
|----------------------|---------------|------------------------|---------------|
| ■ Stylus | L1108P | ■ Recovery bag | CS3027 |
| ■ Support gabarit | L11S44 | ■ Water collector | M0510A |
| ■ Deblocker plier | N82A03 | ■ Hexagonal key 2,5 mm | CX1007 |
| ■ Calibration tool | C20K01 | ■ Flat key 5,5x7 | CX1023 |
| ■ Water feeding hose | CS3017 | ■ Subset probe tip | N95S80 |

SPINDLE MODULE

| | |
|----------------------|---------------|
| ■ Drill bit ø 0,8 mm | M1557A |
| ■ Drill bit ø 1 mm | M1559A |
| ■ Mandrel head | M15S55 |



NEKSIA



| | Ø 22 mm | Ø 18/14 mm | Pads Weco 19/17 |
|------------------------------------|------------------------------|-----------------------------|-----------------|
| Pads | GAM222 (Pack of 20) | GAM218 (Pack of 20) | |
| Blocks | GAM403 (Roll of 1000) | GAM316 (Rol of 1000) | |
| Block Holder (Left Side) | M24A16 | M24A15 | M24A17 |
| Clip-on plate subassy (right side) | M24A12 | M10A17 | M24A19 |
| Flexible stop | M24A33 (Pack of 10) | M1017A | |





CONNECTORS

| | | | |
|--------------------------|---------------|------------------------|---------------|
| ■ Power cord (EU) | CA6320 | ■ Fuse 2 A Tempo, 5x20 | CA1015 |
| ■ Power cord (US) | N66R43 | ■ Fuse 4 A Tempo 5x20 | CA1035 |
| ■ Crossed Ethernet cable | X83A01 | | |

ACCESSORIES

| | | | |
|-----------------------------|---------------|------------------------|---------------|
| ■ Edger adjusting gauge | N82A11 | ■ Water collector | M0510A |
| ■ Orma plano lens | X83A15 | ■ Hexagonal key 2,5 mm | CX1007 |
| ■ Deblocker plier | N82A03 | ■ Hexagonal key 3 mm | CX1005 |
| ■ Calibration tool + button | X88A09 | ■ Flat key 5,5 / 7 mm | CX1023 |
| ■ Water feeding hose | CS3017 | ■ Bent M Key TORX T10 | CX1025 |
| ■ Recovery bag | CS3027 | | |



DELTA - DELTA RC - DELTA T SERIES



Ø 25 mm



Ø 18 mm



Ø 18/14 mm

| | | | | |
|---------------------------------------|-----------------------------|---------------------------------|---------------------------------|---------------------------------|
| | Blocks | GAM202 (Pack of 20) | GAM203 (Pack of 10) | GAM216 (Pack of 10) |
| | Pads | GAM200 (Roll of 1000) | GAM306 (Roll of 1000) | GAM316 (Roll of 1000) |
| | Block holder (Left side) | M1590C | M1590L | M1590D |
| Clip-on plate subassy (Right side) | Complete set | M10A08 | | |
| | Plate with flexible stop | M10A09 | M10A10 | M10A17 |
| | Flexible stop | N9581D | N9582B | M1017A |

CONNECTORS

| | | | |
|--------------------------|---------------|------------------------|---------------|
| ■ Power cord (EU) | CA6320 | ■ Fuse 2 A Tempo, 5x20 | CA1015 |
| ■ Power cord (US) | N66R43 | ■ Fuse 4 A Tempo 5x20 | CA1035 |
| ■ Crossed Ethernet cable | X83A01 | | |

BAR CODES

| | | | |
|---------------------------------------------------|---------------|----------------------------------|---------------|
| ■ Complete bar code option (for tracer and edger) | L14A00 | ■ Set of labels from 401 to 600 | X95A04 |
| ■ Bar code reader | DOUA24 | ■ Set of labels from 601 to 800 | X95A05 |
| ■ Set of labels from 001 to 200 | X95A02 | ■ Set of labels from 801 to 1000 | X95A06 |
| ■ Set of labels from 201 to 400 | X95A03 | | |

ACCESSORIES

| | | | |
|-------------------------|---------------|------------------------|---------------|
| ■ Edger adjusting gauge | N82A11 | ■ Recovery bag | CS3027 |
| ■ Orma plano lens | X83A15 | ■ Water collector | M0510A |
| ■ Deblocker plier | N82A03 | ■ Hexagonal key 2,5 mm | CX1007 |
| ■ Dust cover tracer | X8890A | ■ Hexagonal key 3 mm | CX1005 |
| ■ Dust cover Edger | N8291A | ■ Flat key 5,5 / 7 mm | CX1023 |
| ■ Water feeding hose | CS3017 | ■ Bent M Key TORX T10 | CX1025 |



TRIPLETS RANGE : JESSIE - JESS - JESS D



| | Ø 22 mm | Ø 18/14 mm |
|----------------------------------------|---------------------------------|---------------------------------|
| Blocks | GAM222 (Pack of 20) | GAM218 (Pack of 20) |
| Pads | GAM403 (Roll of 1000) | GAM316 (Roll of 1000) |
| Block holder (Left side) | M24A16 | M24A15 |
| Clip-on plate subassembly (Right side) | M24A12 | M10A17 |
| Flexible stop | M24A33 (pack of 10) | M1017A |



CHAIN 900 AND PROFIL

CHAIN 900

| | | | |
|---------------------------------------|---------------|---------------------------------|---------------|
| ■ Auget LED board | CA5060 | ■ Bar code reader holder | X8398S |
| ■ Orma plano lens | X83A15 | ■ Bar code reader | X83A18 |
| ■ Orange block (Pack of 50) | GAM072 | ■ Set of labels from 001 to 076 | X83A05 |
| ■ Block holder ø 18/14 mm (left side) | N51A02 | ■ Plate ø 25 mm (Right side) | N51A10 |
| ■ Block holder ø 25 mm (left side) | N51A03 | ■ Plate ø 18/14 mm (Right side) | MBA807 |

PROFIL

| | | | |
|---------------------------------------|---------------|---------------------------------|---------------|
| ■ Auget LED board | CA5060 | ■ Block holder steel screw | CV6899 |
| ■ Orma plano lens | X83A15 | ■ Suction cup Essilor | GAM050 |
| ■ Orange Block (Pack of 50) | GAM072 | ■ Universal pattern holder nose | N51S77 |
| ■ Block holder ø 25 mm (left side) | N51A03 | ■ Plate ø 25 mm (Right side) | N51A10 |
| ■ Block holder ø 18/14 mm (left side) | N51A02 | ■ Plate ø 18/14 mm (Right side) | MBA807 |

HAND EDGERS



DIAFINE

| | | |
|------------------------------------|-----------|---------------|
| ■ Sponge | Pack of 3 | GAM094 |
| ■ Dumper | | CY6008 |
| ■ Tank | | N6510D |
| ■ White cover | | N6570C |
| ■ Grey cover (Organic/PC version) | | N6571C |

MMW

| | | |
|--------------------------------------|------------|---------------|
| ■ Cleaning stone for roughing wheel | Pack of 10 | MMW10S |
| ■ Cleaning stone for finishing wheel | Pack of 10 | MMW10R |
| ■ Large sponge | | MMW10A |
| ■ Small sponge | | MMW10B |

MD2

| | | |
|-------------------|-----------|---------------|
| ■ Bulb | Pack of 4 | GAM095 |
| ■ Spinckler joint | | CH6004 |



DRILLING DEVICES



PER200

- ESSILOR adapter **PER210**
- ESSILOR Profil M adapter **PER211**
- NIDEK, WECO, BRIOT adapter **PER220**
- NIDEK, INDO,HOYA adapter **PER221**
- Lens clamp bumper **PER230**

GROOVING MACHINES



MRT

- Small B size adapter **MRT930**
- Gamma/kappa adapter **MRTA10**
- Oil **MRT986**
- Chain **MRT964**
- Sponge **MRT904**
- Centring pin **MRT963**

PATTERN MAKER



MGT

- Round patterns Pack of 100 **GAM076**
- Round patterns Pack of 200 **GAM077**
- Punch **MGT900**

RAINYL

- Sponge Pack of 3 **GAM091**
- Nylon roller Pack of 2 **N15208**
- Suction cup for lens holder **N15S03**
- Suction cup with screw **N15130**
- Depth adjusting screw **CV6177**
- Screw and nut for table holding Pack of 2 **N15S11**



MEASUREMENTS



| | | | |
|---------------|-------------------------|-----------|---------------|
| PUPILLOMETERS | ■ Digital CRP Nose pads | Pack of 2 | C16S01 |
| | ■ PUPILL'ON Nose pads | Pack of 2 | PUP101 |
| VP SYSTEM | ■ Lamp 2,5 v | | CA5005 |
| MHP | ■ Retrofit Kit | | MHPS50 |

DEMONSTRATORS



| | | | |
|--------|---------------------------------------------|-----------|---------------|
| DPE60 | ■ Bulb | | DPE611 |
| | ■ Fuse 0.1 A | | DPE601 |
| DPE100 | ■ UV Lamp | | DPE111 |
| TENO70 | ■ Screwed Lamp 220 v | | PRO016 |
| | ■ Tube Lamp 220 v 15 w | Pack of 2 | GAM099 |
| TEN100 | ■ Lamp | | TEN110 |
| PAL ID | ■ Filter for mineral lens | | PALA02 |
| | ■ Filter for organic and polycarbonate lens | | PALA01 |
| | ■ Fluorescent tube | | CA5050 |



LENSMETERS

| | | | |
|-----------------|----------------------|--|---------------|
| CLE070 / CLE060 | ■ Lens clamp | | CLE602 |
| | ■ Lens holder | | CLE626 |
| | ■ Red marking pins | | CLE601 |
| | ■ White marking pins | | CLE681 |
| | ■ Paper roll | | C50900 |

| | | | |
|--------|---------------------------------|------------|---------------|
| MLM100 | ■ Set of 3 red ink cartridges | Pack of 3 | MLMRI3 |
| | ■ Set of 3 white ink cartridges | Pack of 3 | MLMWI3 |
| | ■ Set of 10 lens supports | Pack of 10 | MLMP10 |
| | ■ Ocular protection | | MLM105 |
| | ■ Ink | | MLM106 |

| | | | |
|--------|-----------------------|-----------|---------------|
| LME 60 | ■ Red ink | | GAM084 |
| | ■ Dust cover | | LMEA66 |
| | ■ End tip | Pack of 3 | LME626 |
| | ■ Lens holder | | LMEA63 |
| | ■ Contact lens holder | | LMEA65 |



| | | | |
|------|---------------------|-----------|---------------|
| X75 | ■ Lamp | Pack of 2 | GAM079 |
| | ■ Red ink | | GAM084 |
| | ■ Bumper | | CY6008 |
| | ■ Lift spring | | GAM107 |
| | ■ Felt roll | Pack of 2 | GAM081 |
| | ■ Metal + felt roll | | GAM083 |
| | ■ Foam roll | Pack of 2 | GAM082 |
| AXIL | ■ Bulb 6 V 20 W | Pack of 2 | GAM085 |
| | ■ Stamp | Pack of 3 | X80A03 |
| | ■ Paper roll | | CD8032 |



REFRACTION INSTRUMENTS

CPE60/CPE70

| | |
|---------------------|---------------|
| ■ Lamp 12 V 20 W e1 | CPE101 |
| ■ Fuse | CPE606 |
| ■ Lamp 12 V 30 W | CPE618 |
| ■ Lamp 12 V 20 W e1 | CPE609 |
| ■ Projection screen | CPE614 |
| ■ Dust cover | CPE613 |

OPTOPROX

| | |
|-------------------------|---------------|
| ■ Lamp 6 V 3 W | CA5023 |
| ■ Red Maddox Filters | C36400 |
| ■ Polarized lens holder | C36401 |
| ■ Optotype | C36S02 |
| ■ Fuse 400 ma | CA1164 |

ELU080/090

| | |
|---------------------------------------|---------------|
| ■ Straight bulb 220 V 25 W l : 230 mm | ELU815 |
| ■ Circline bulb 220 V 22 W ø 220 mm | ELU822 |



SLE70

| | |
|-----------------------|---------------|
| ■ Dust cover | SLE720 |
| ■ Main lamp | SLE721 |
| ■ Fixation point Lamp | SLE722 |
| ■ Fuse | SLE723 |
| ■ Chin rest paper | AKL200 |

SLE60

| | |
|-----------------------|---------------|
| ■ Fixation point Lamp | SLE616 |
| ■ Main lamp | SLE606 |
| ■ Fuse 2 A | CA1015 |
| ■ Dust cover | SLE618 |
| ■ Chin rest paper | AKL200 |

KME60

| | |
|-------------------|---------------|
| ■ Chin rest paper | AKL200 |
|-------------------|---------------|

REFRACTION INSTRUMENTS

